

TENE

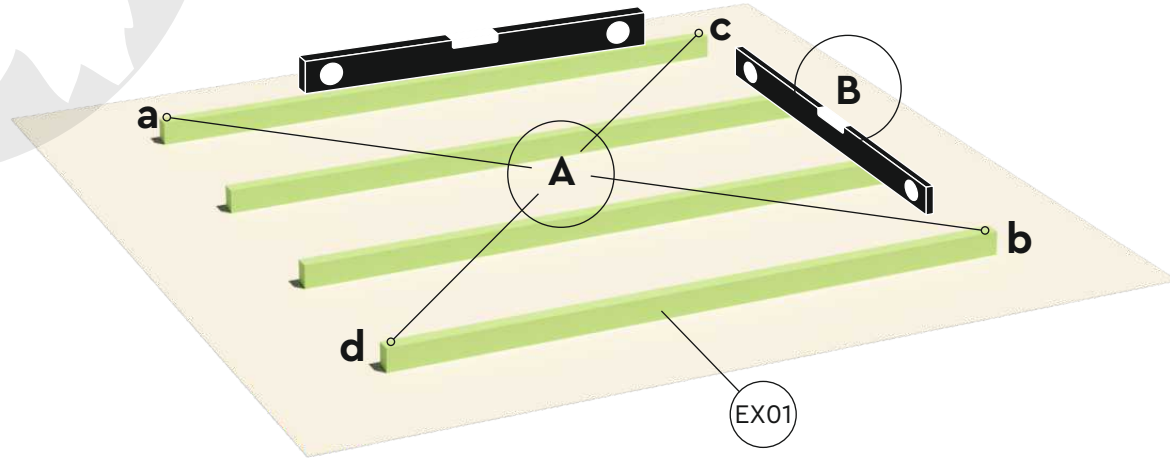

BETTY 28

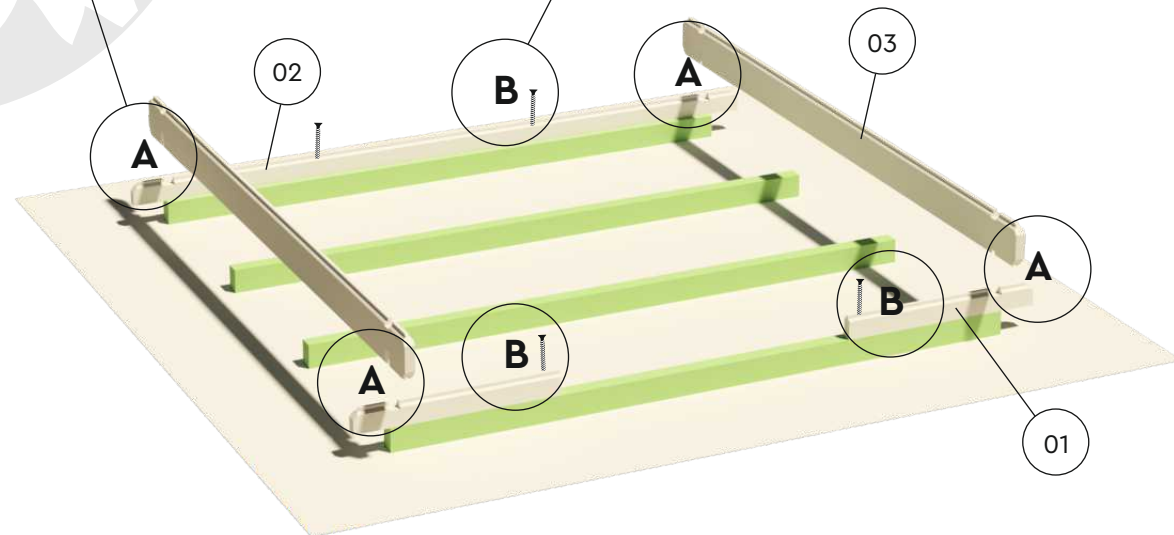
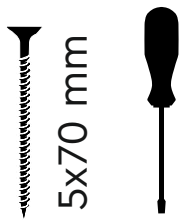
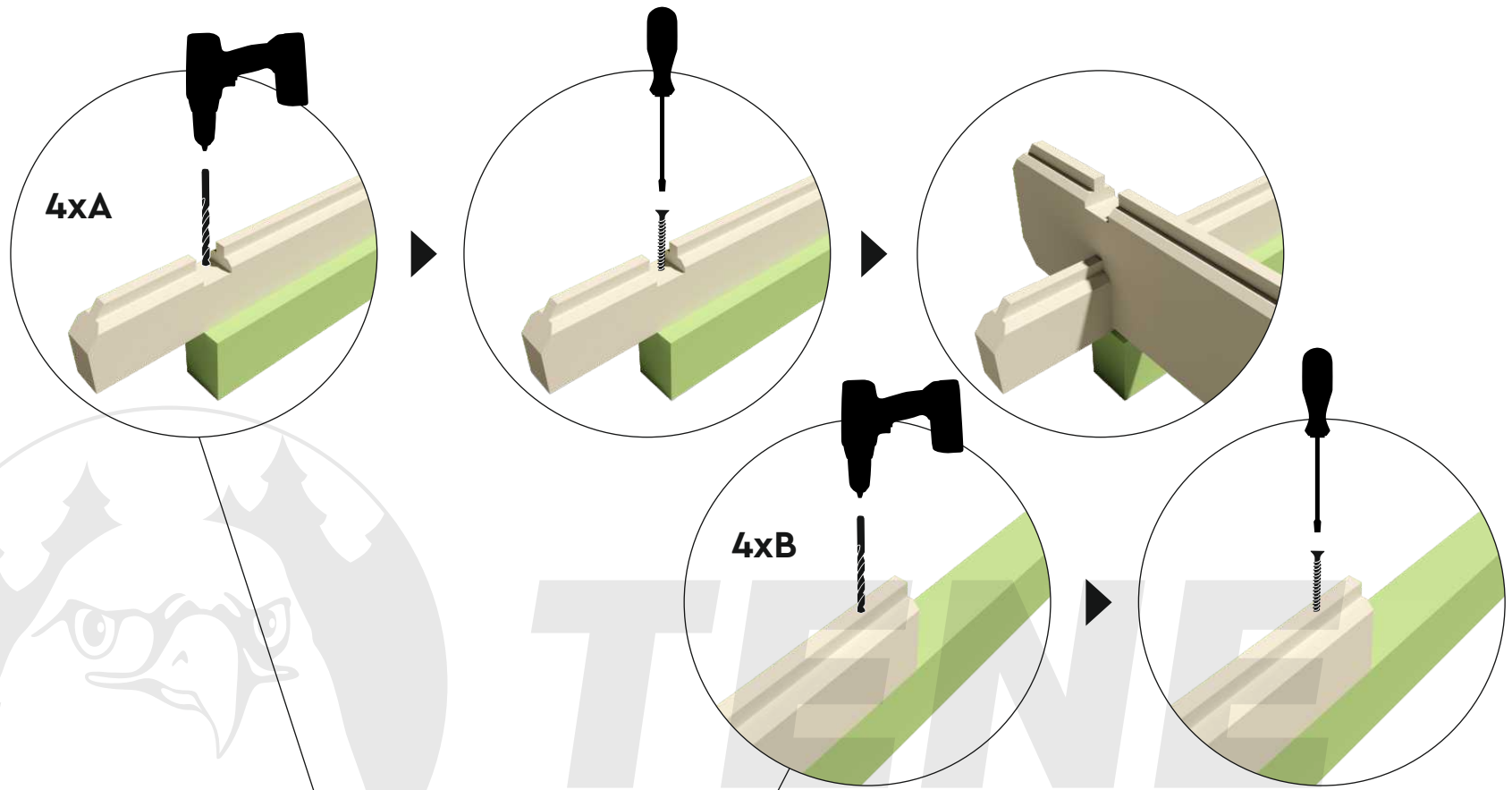

BETTY 28

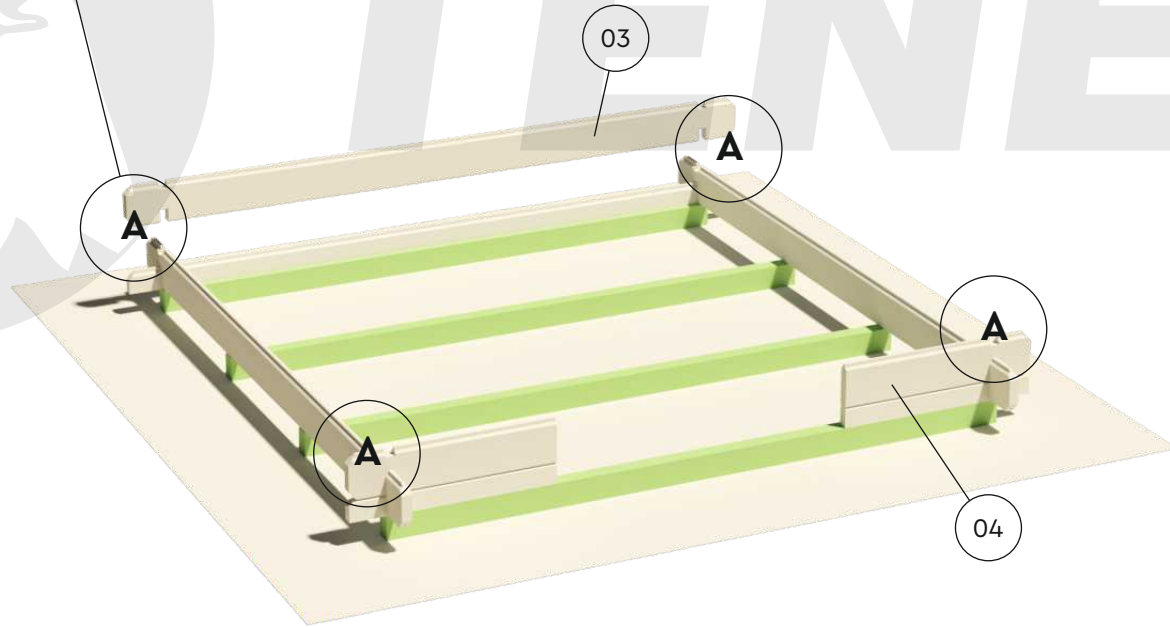
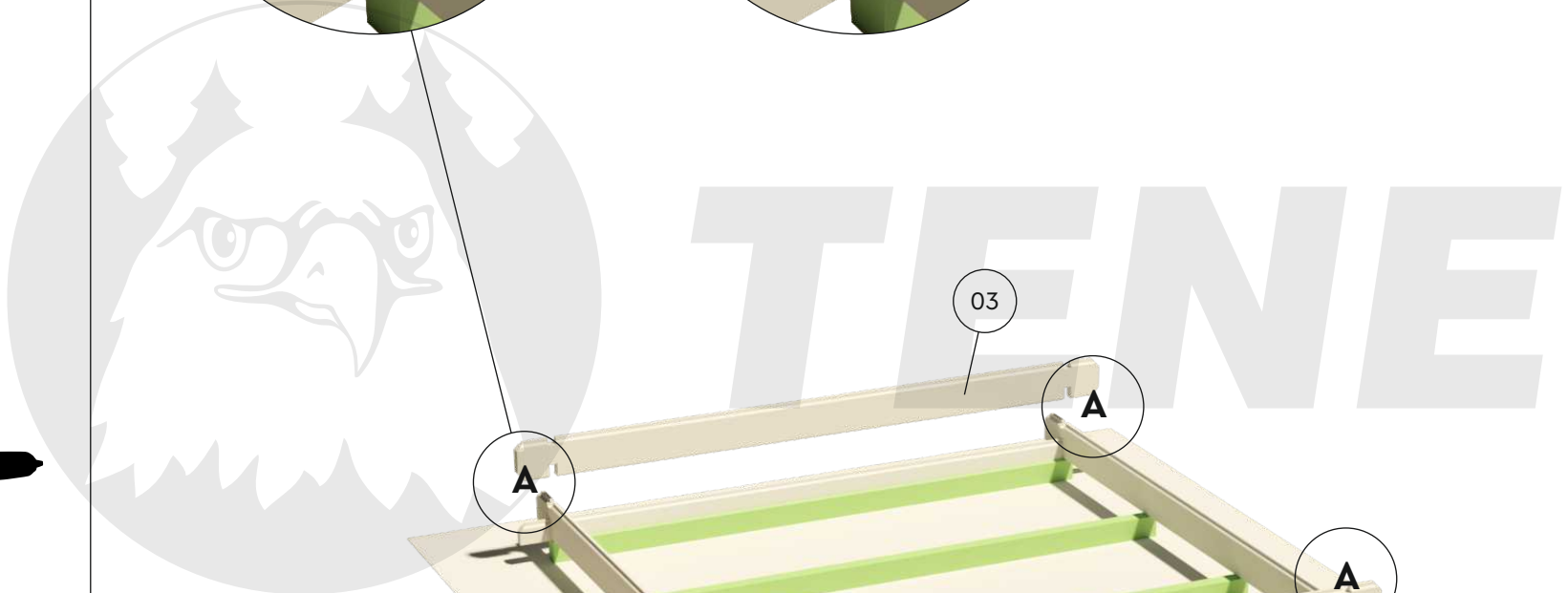
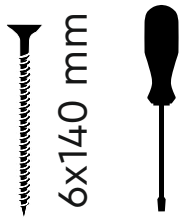
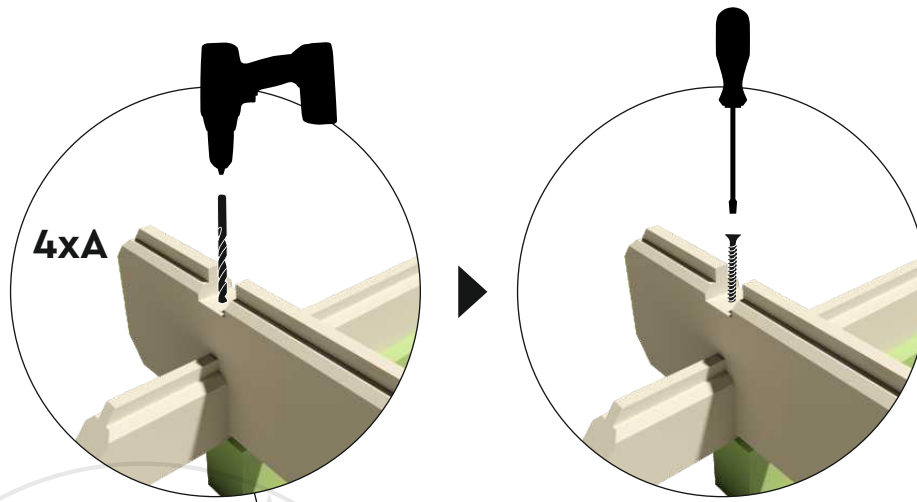

BETTY 28

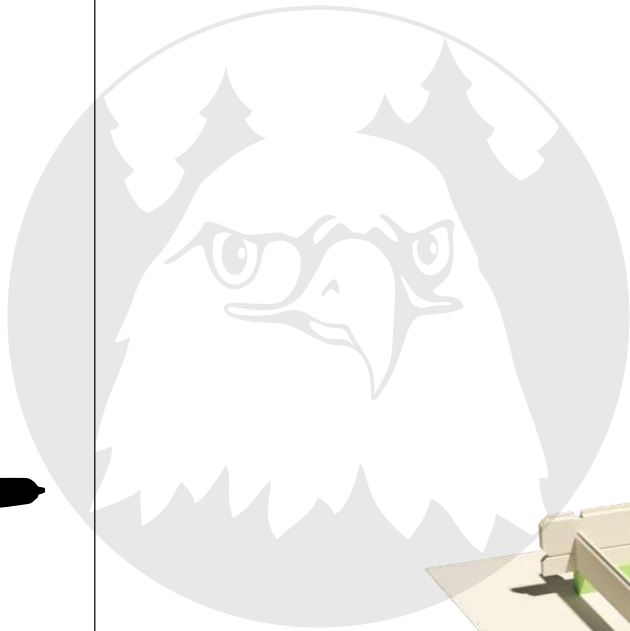

TENE



Ø 5 mm

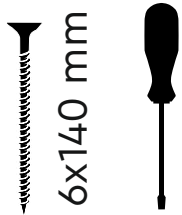

6x140 mm

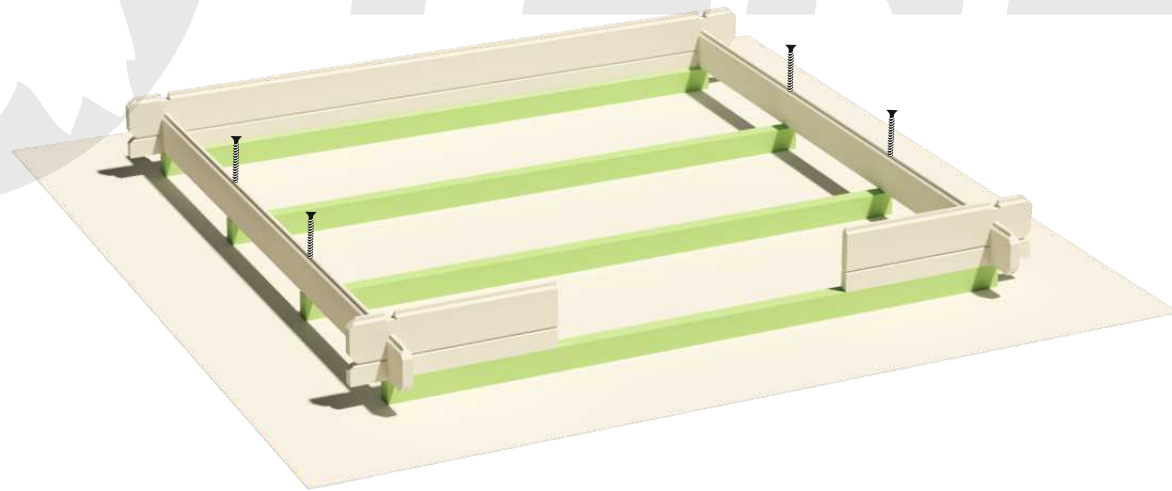

BETTY 28

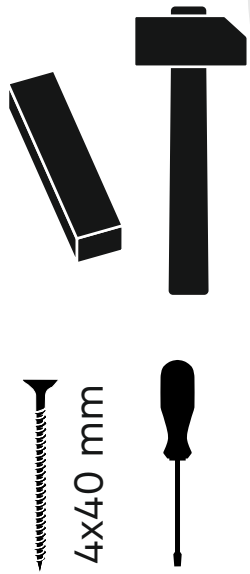
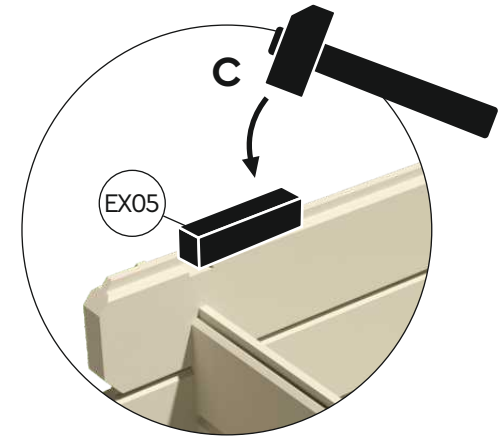
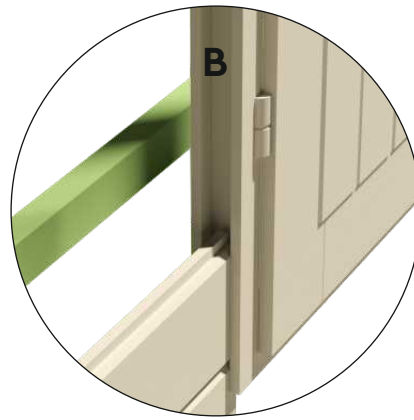
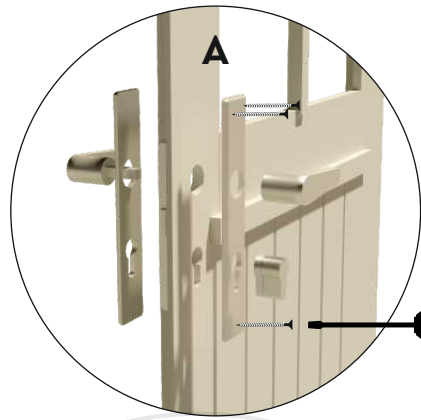

TEWVE



BETTY 28

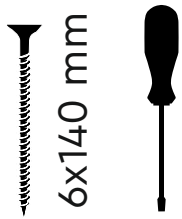
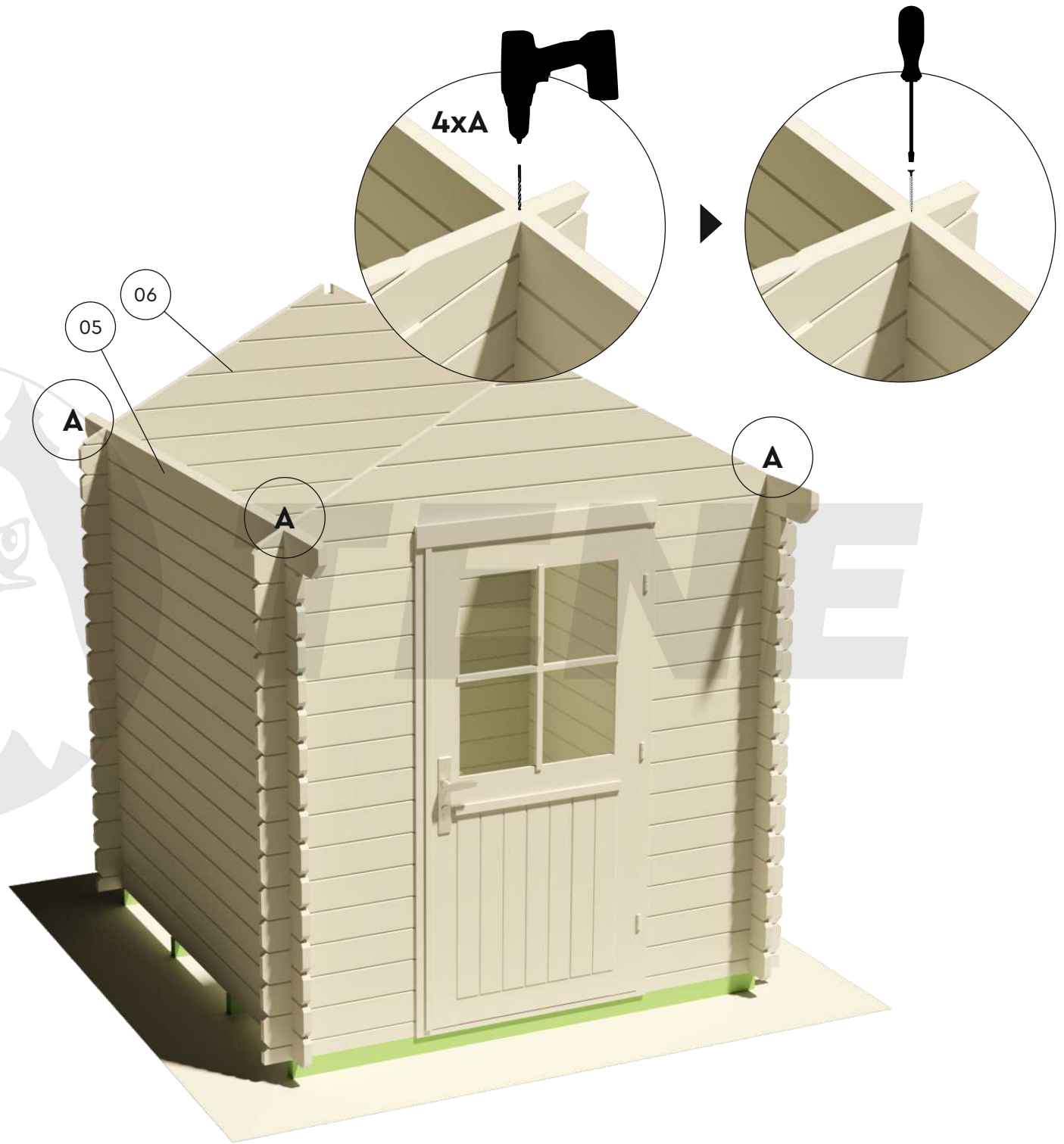

BETTY 28

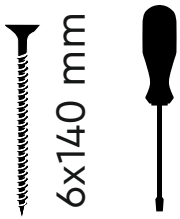
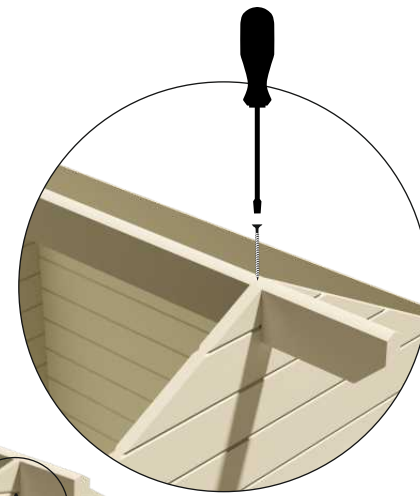
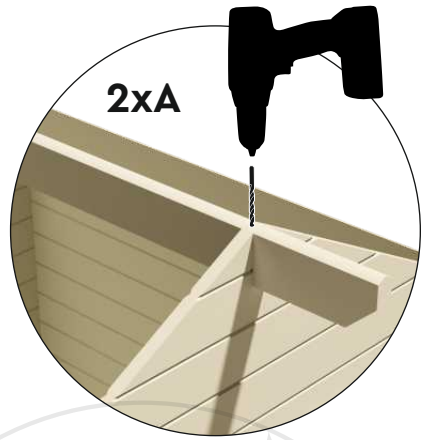

BETTY 28

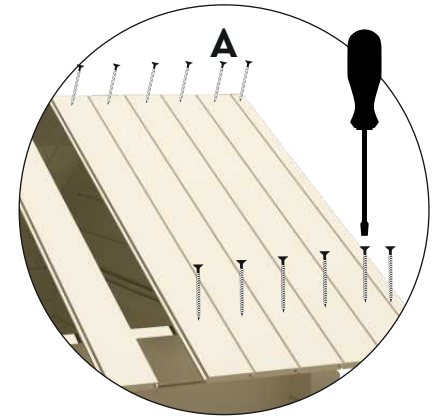
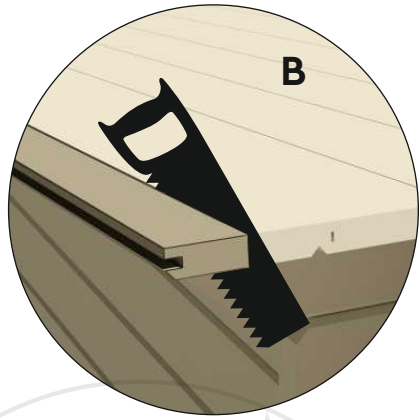

BETTY 28

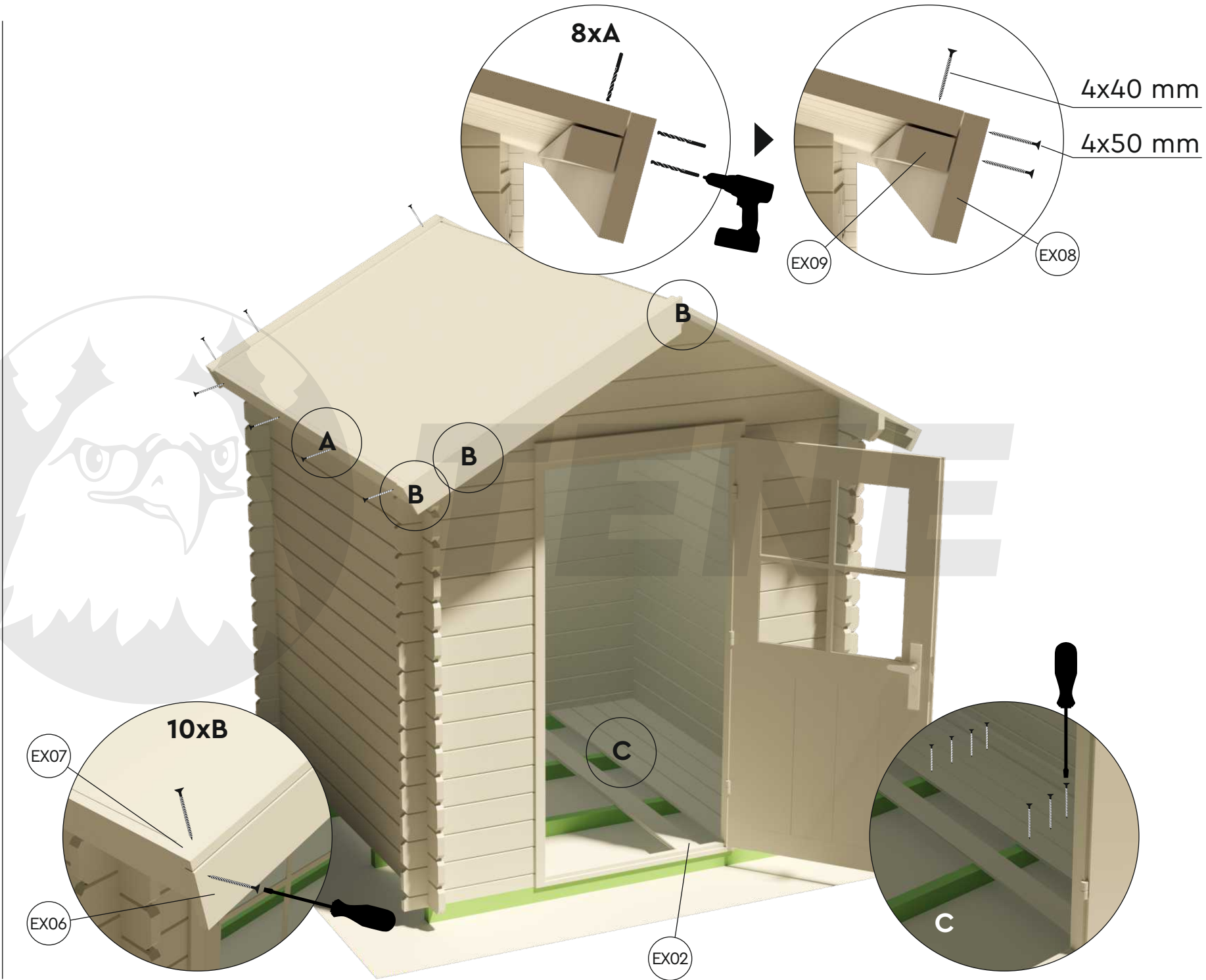
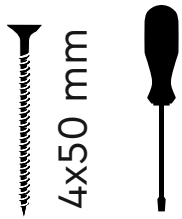
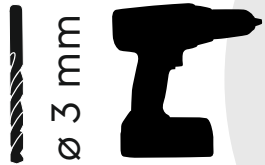

BETTY 28

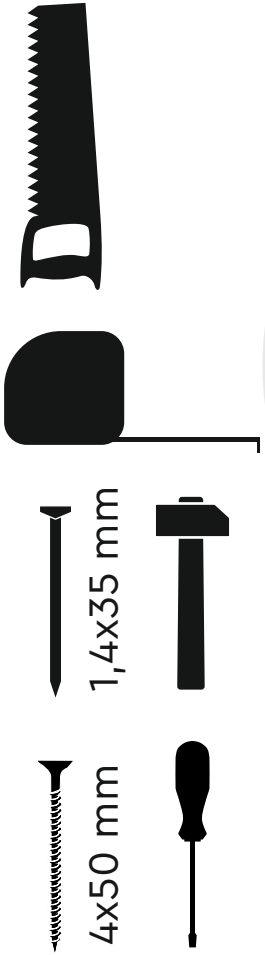
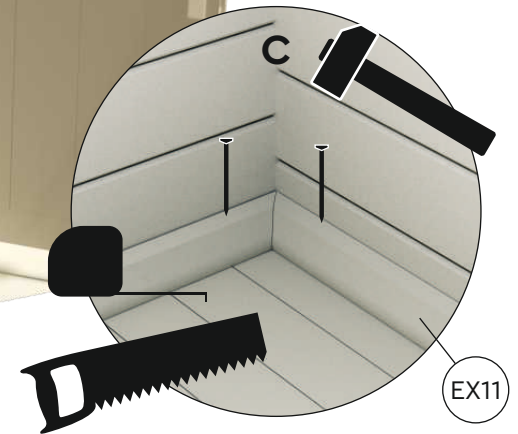
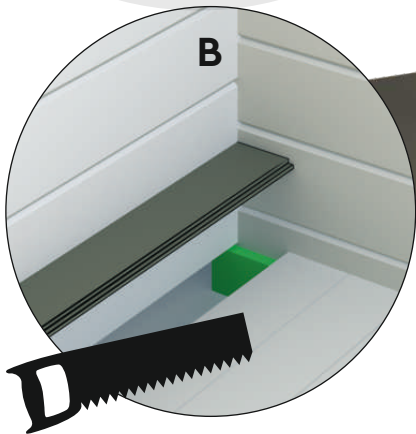
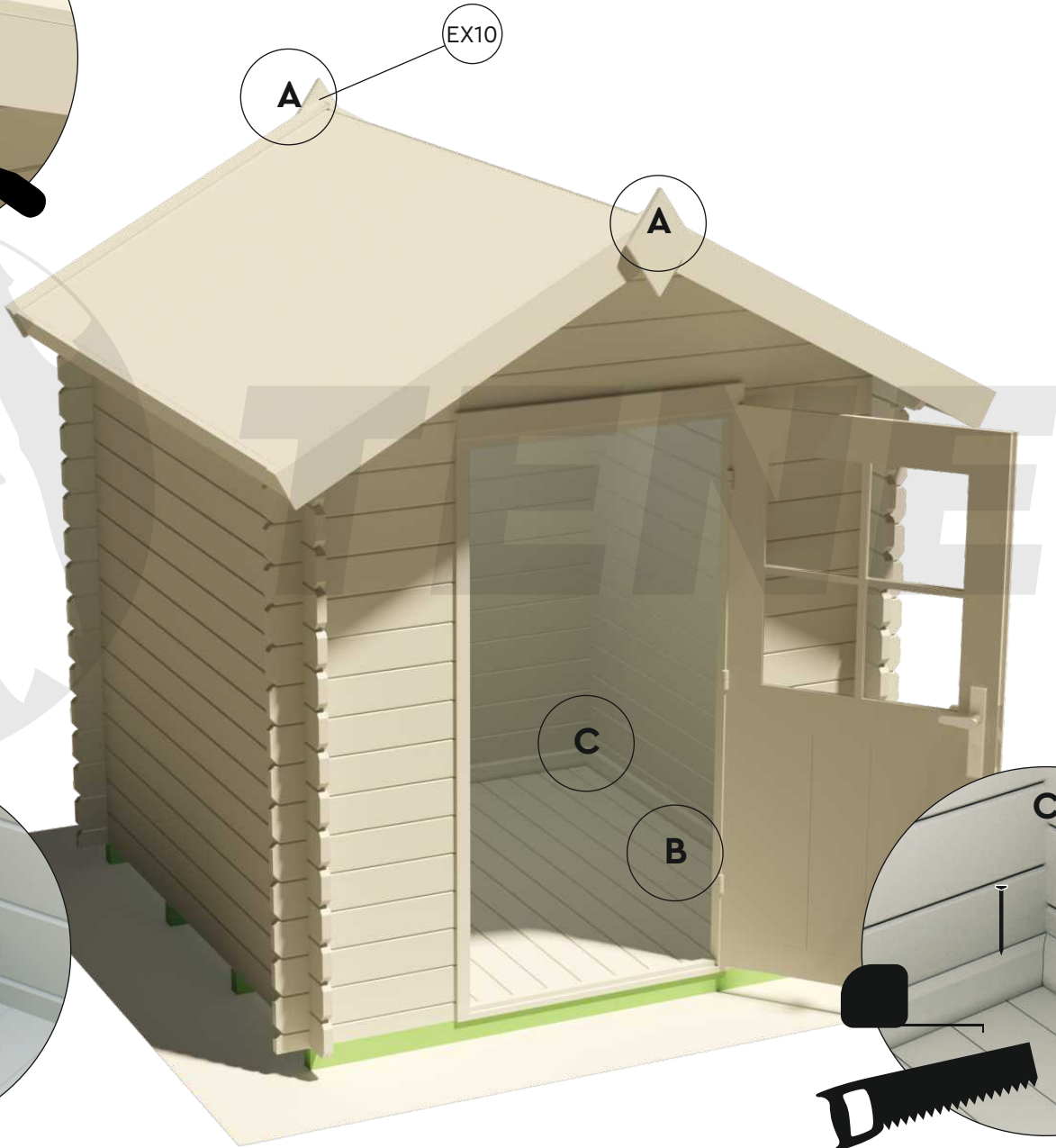
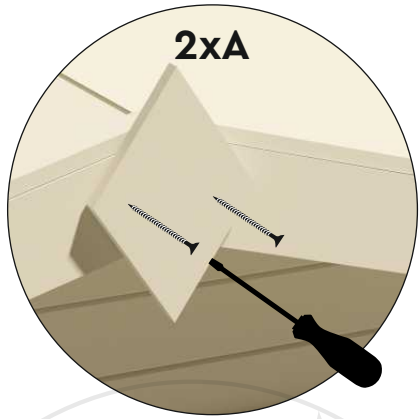

BETTY 28

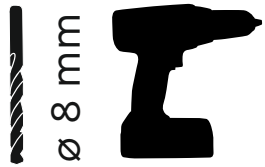
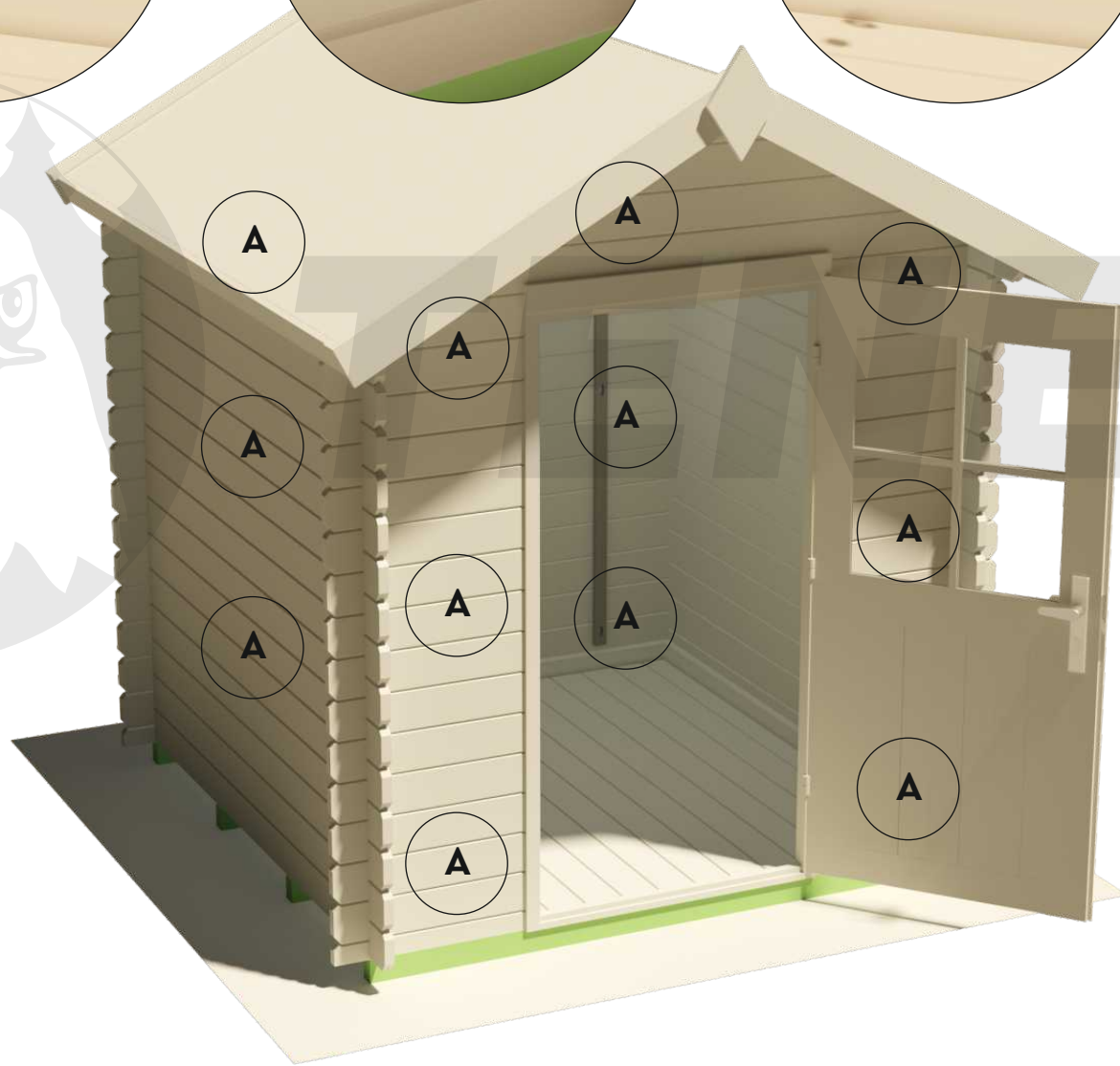
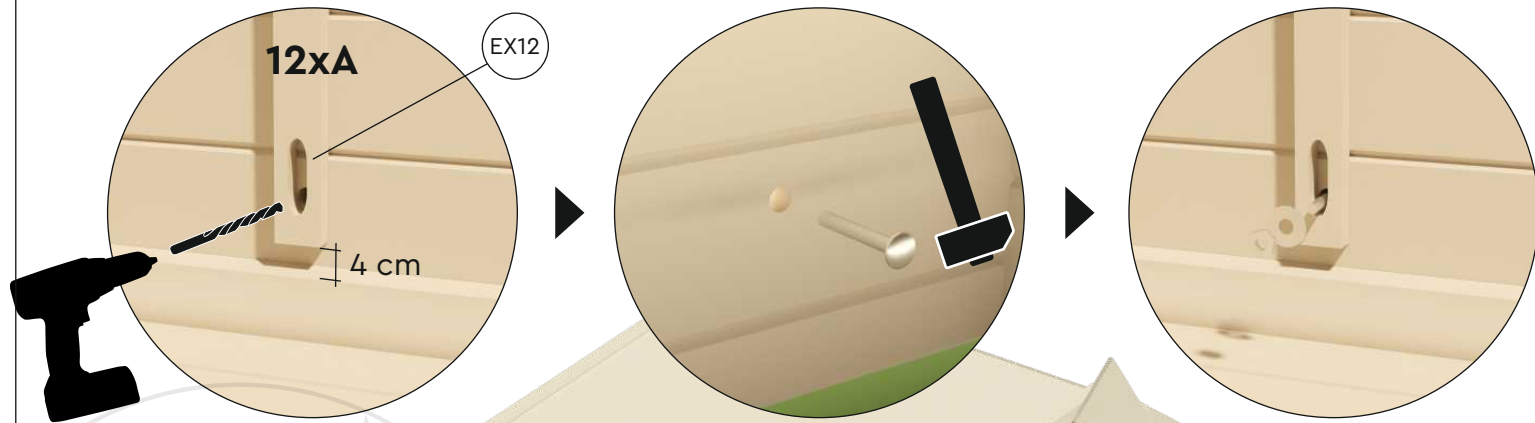

Ø 8 mm

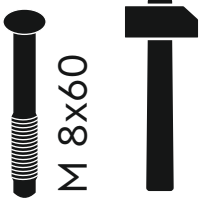

M 8x60

BETTY 28

