

# EMMA 4F 40

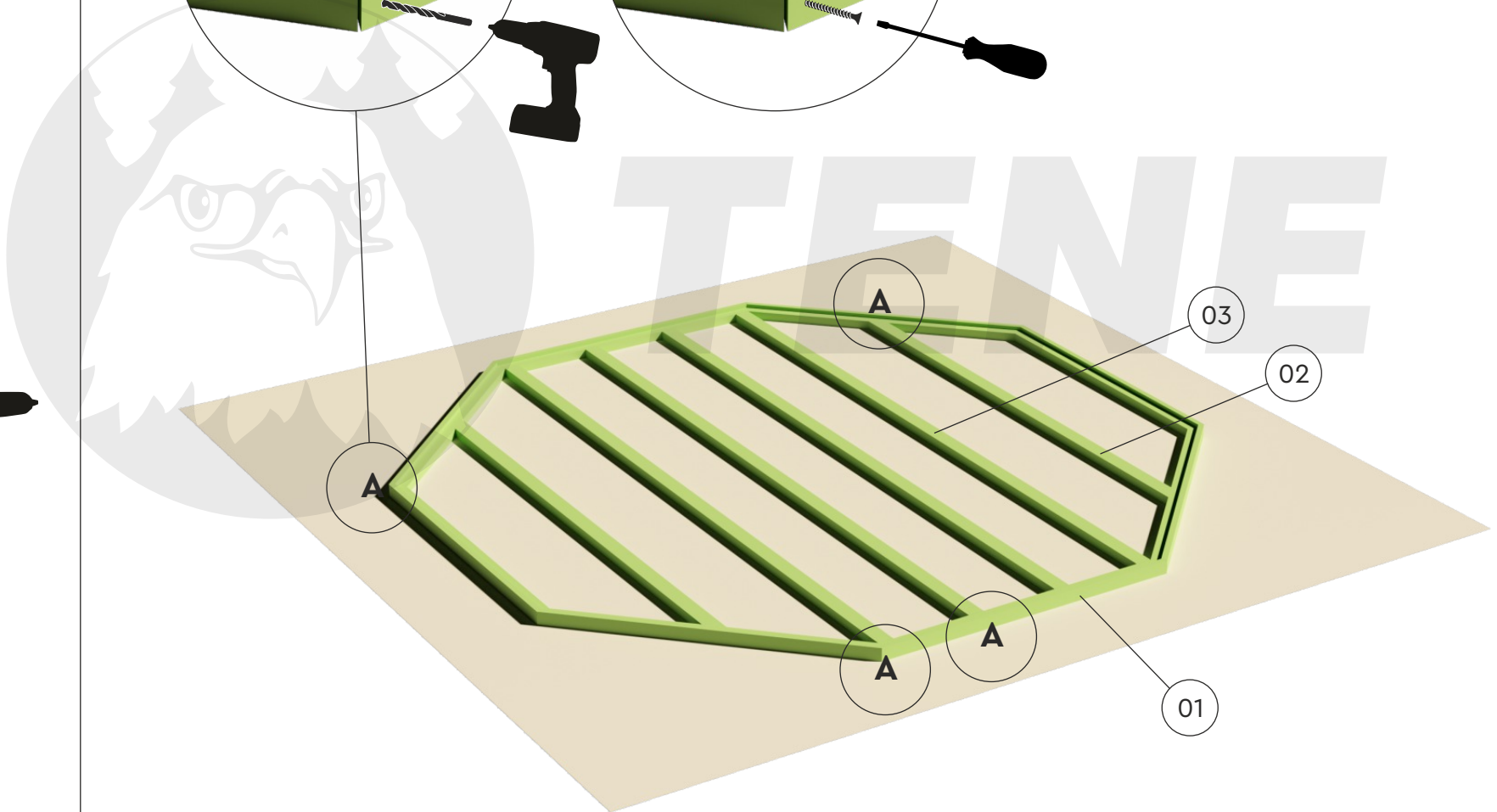

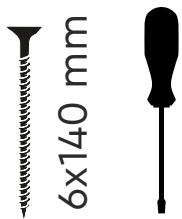

# EMMA 4F 40

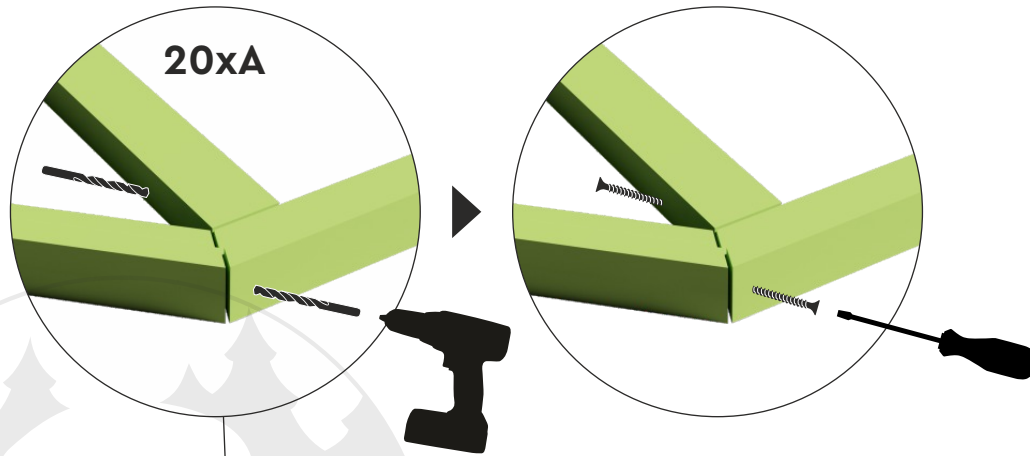
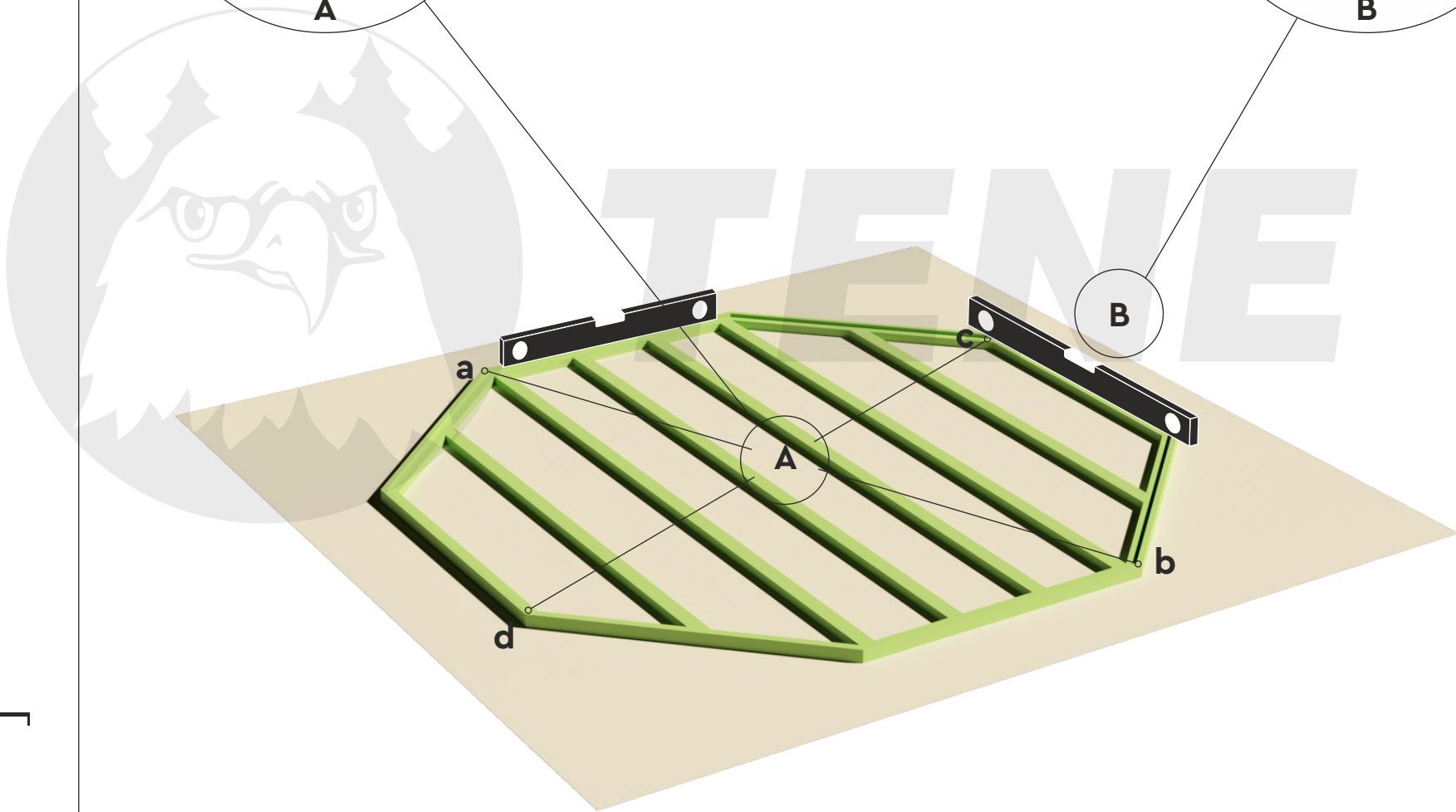
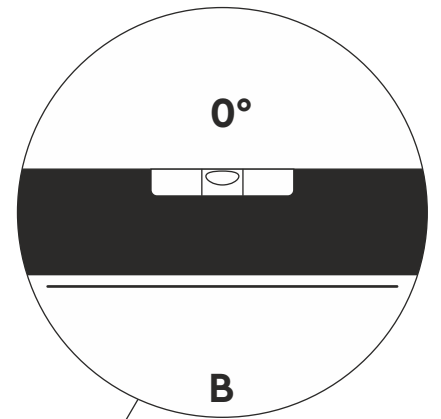
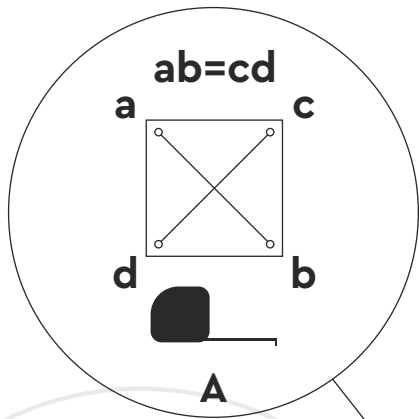
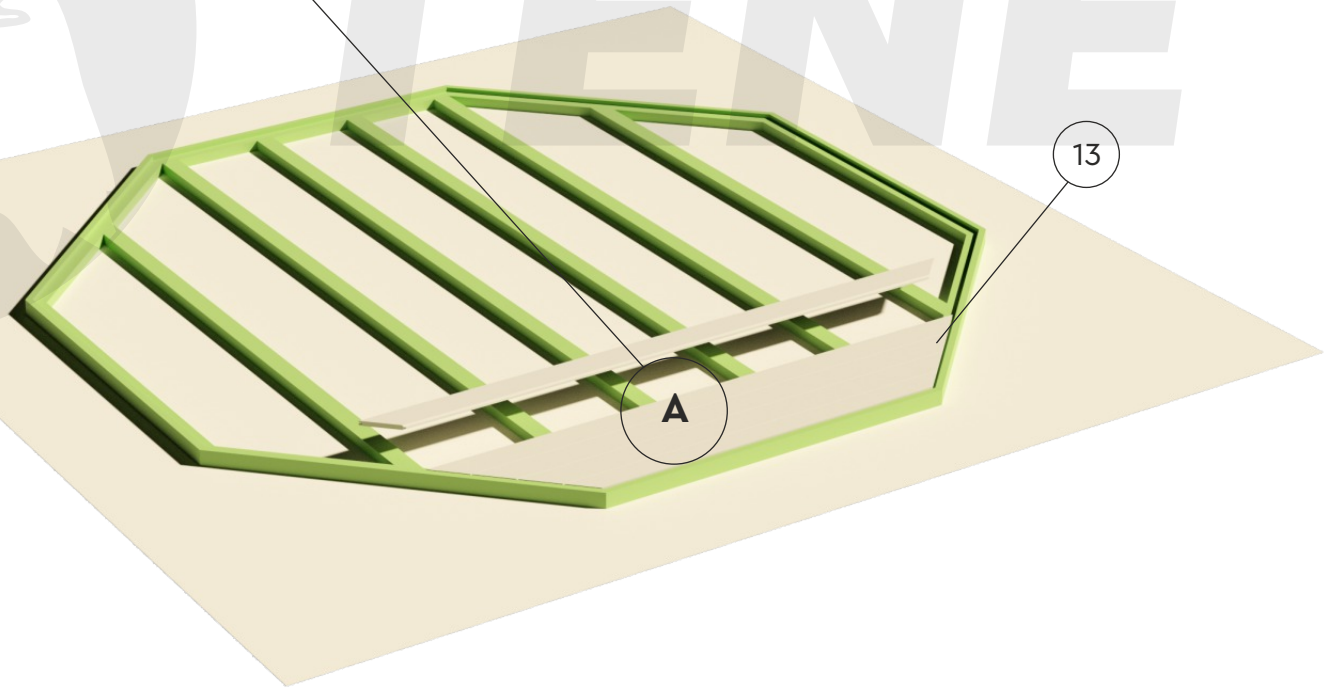
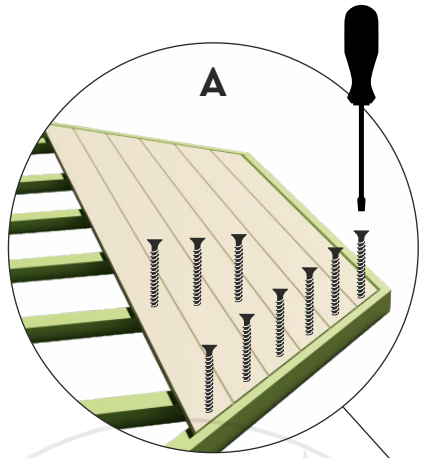

4x50 mm





EMMA 4F 40

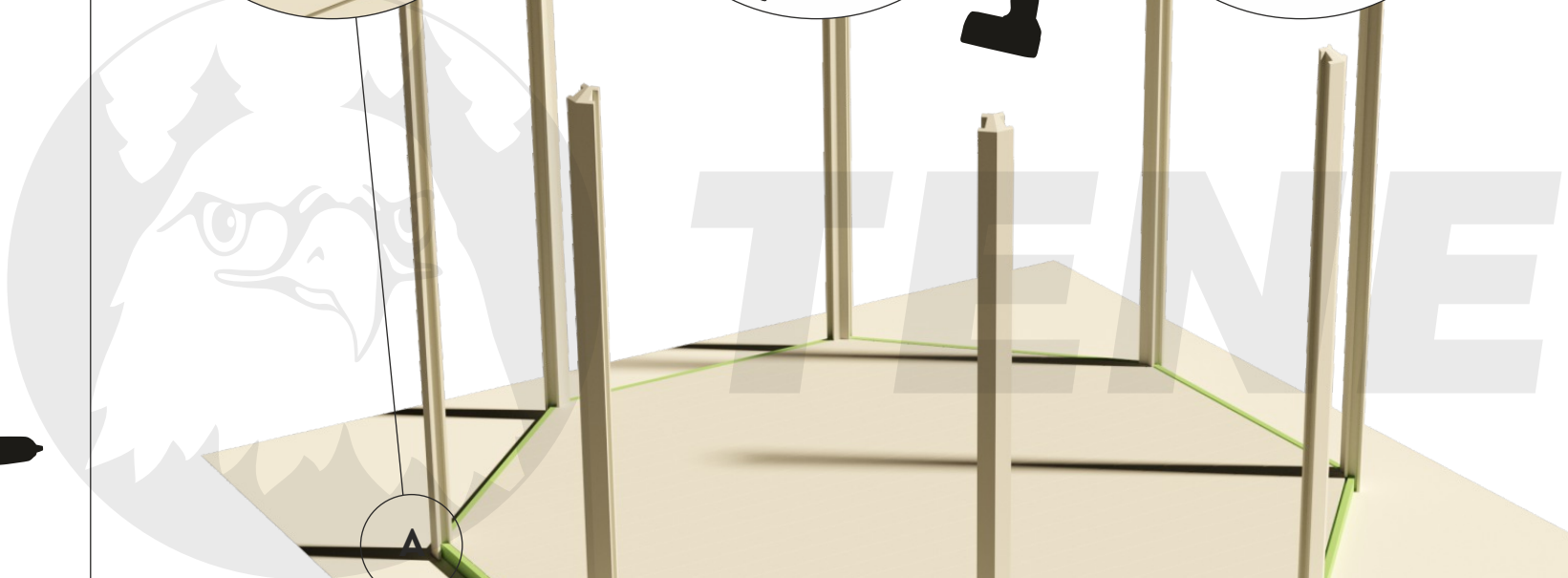
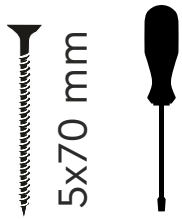
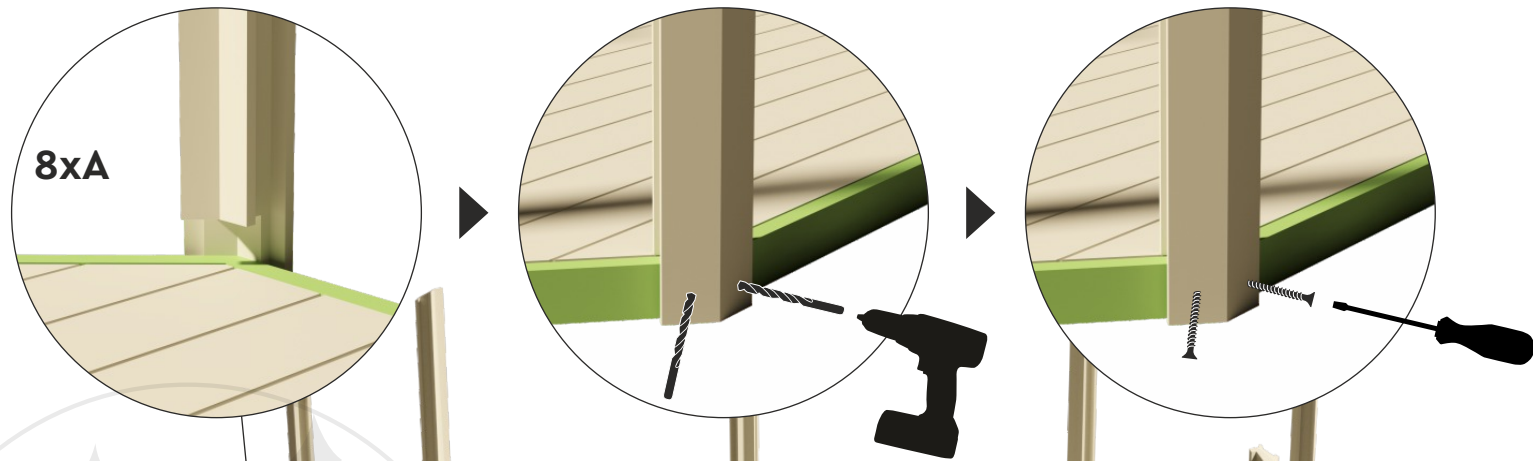

06

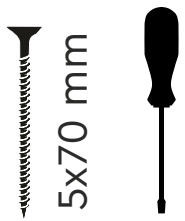
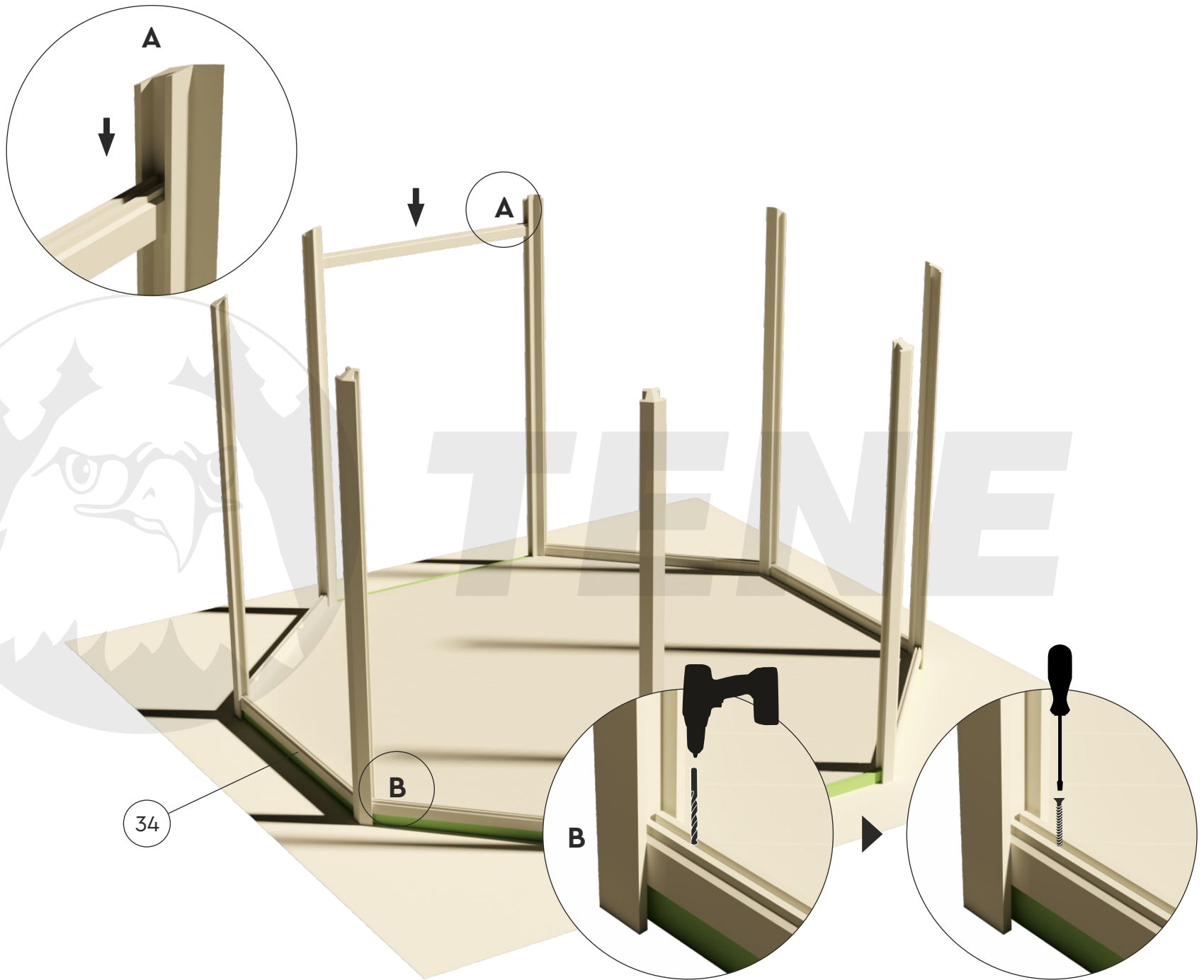

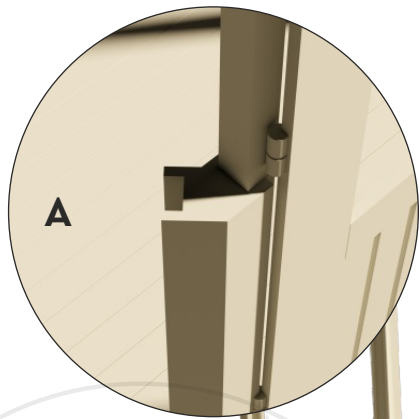

04

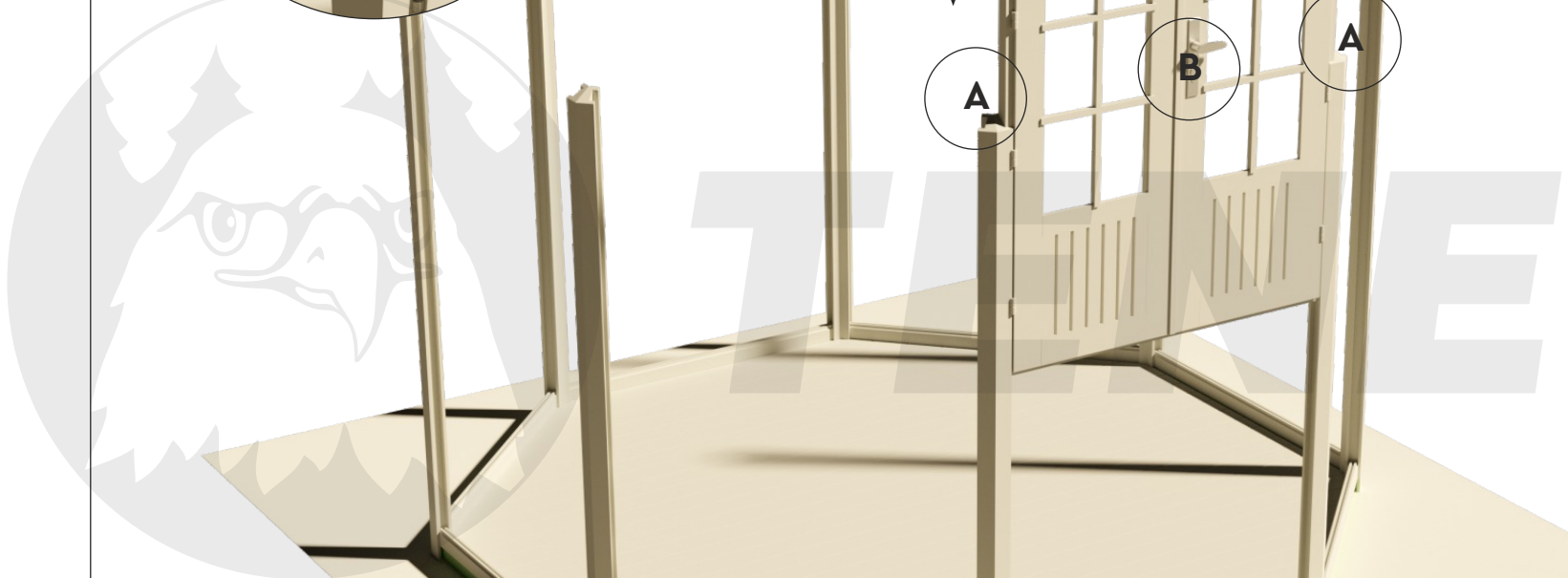
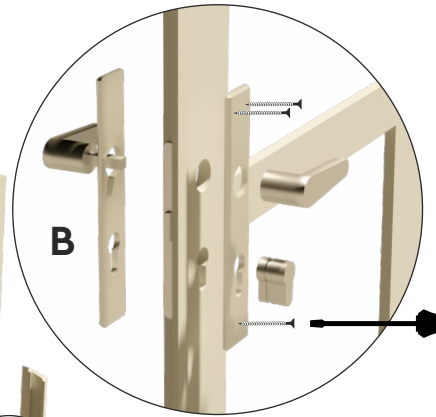

# EMMA 4F 40

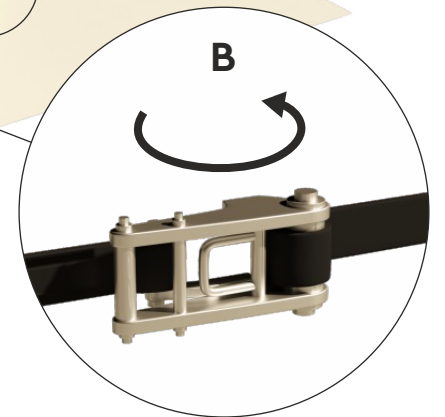
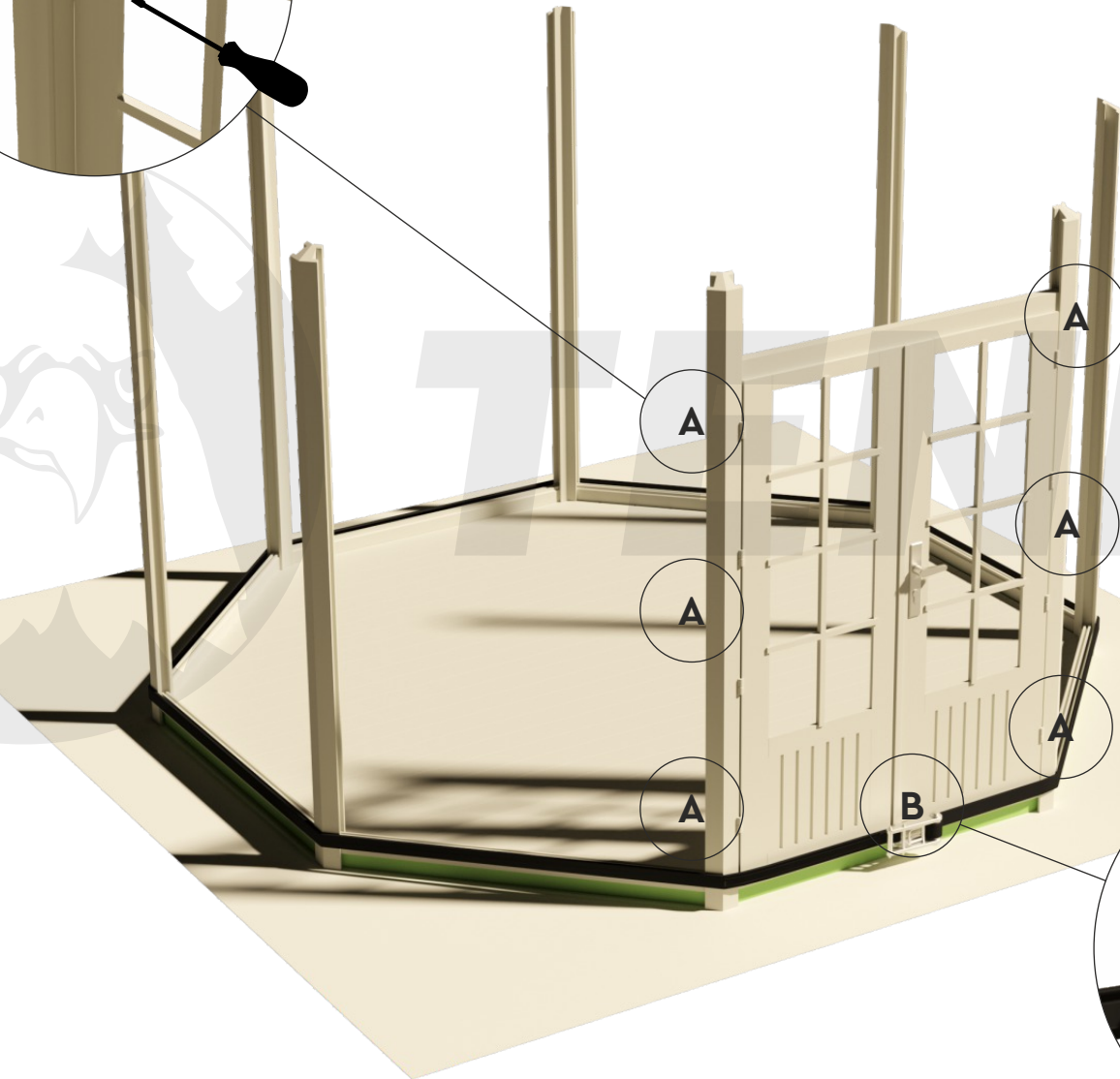
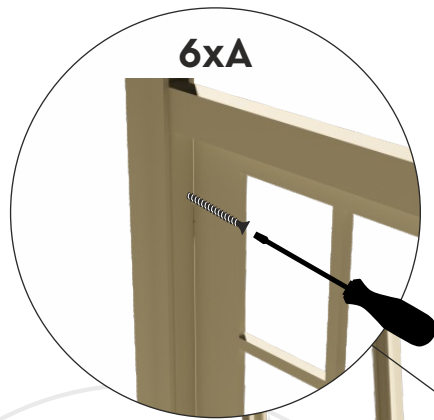
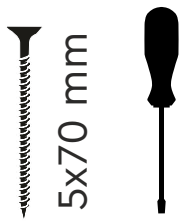
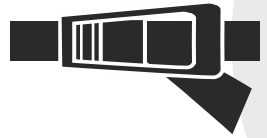

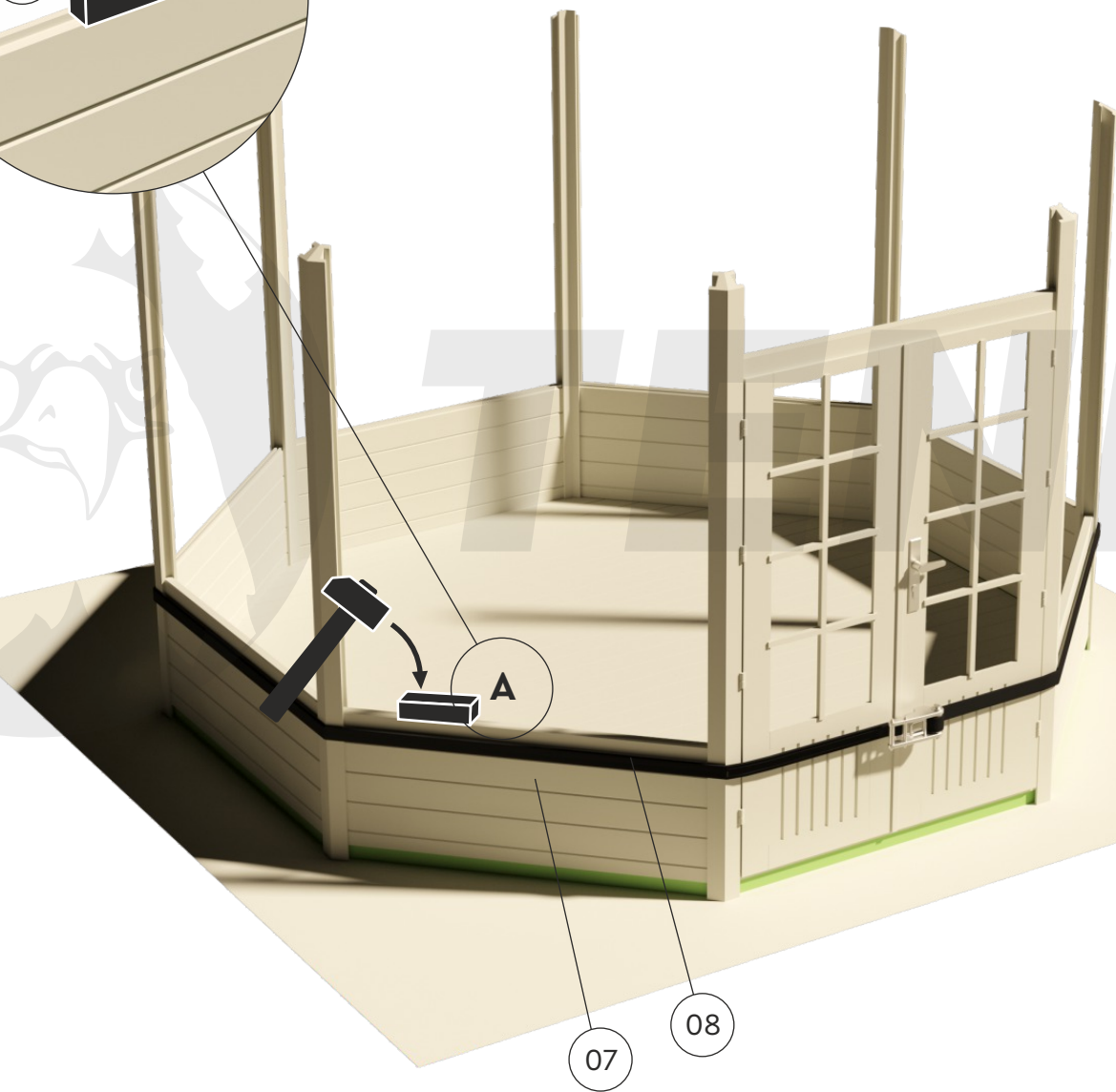
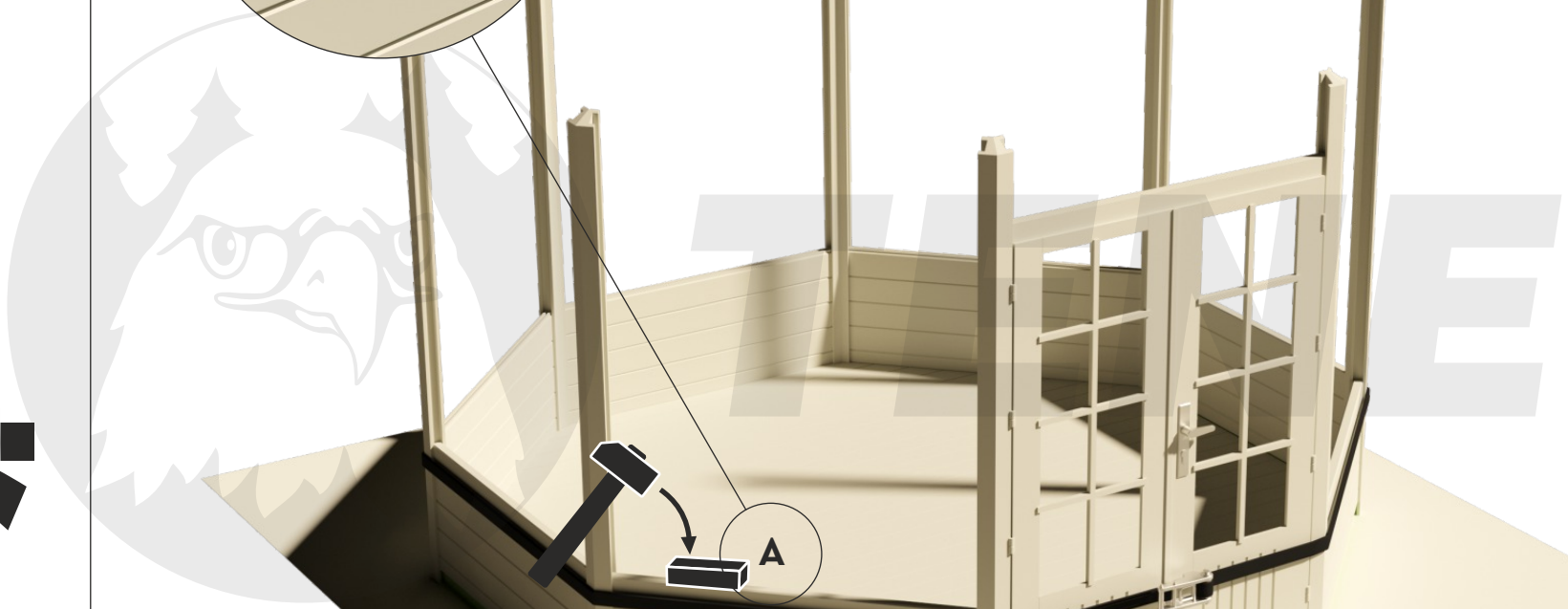
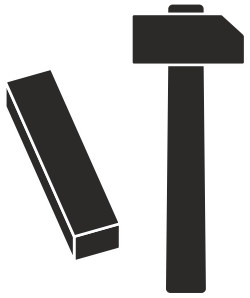
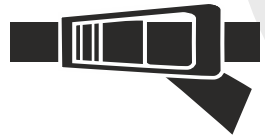
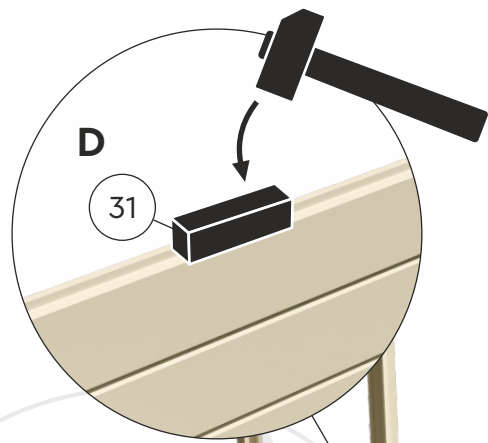

07

08



# EMMA 4F 40

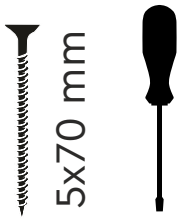
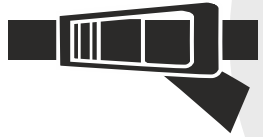
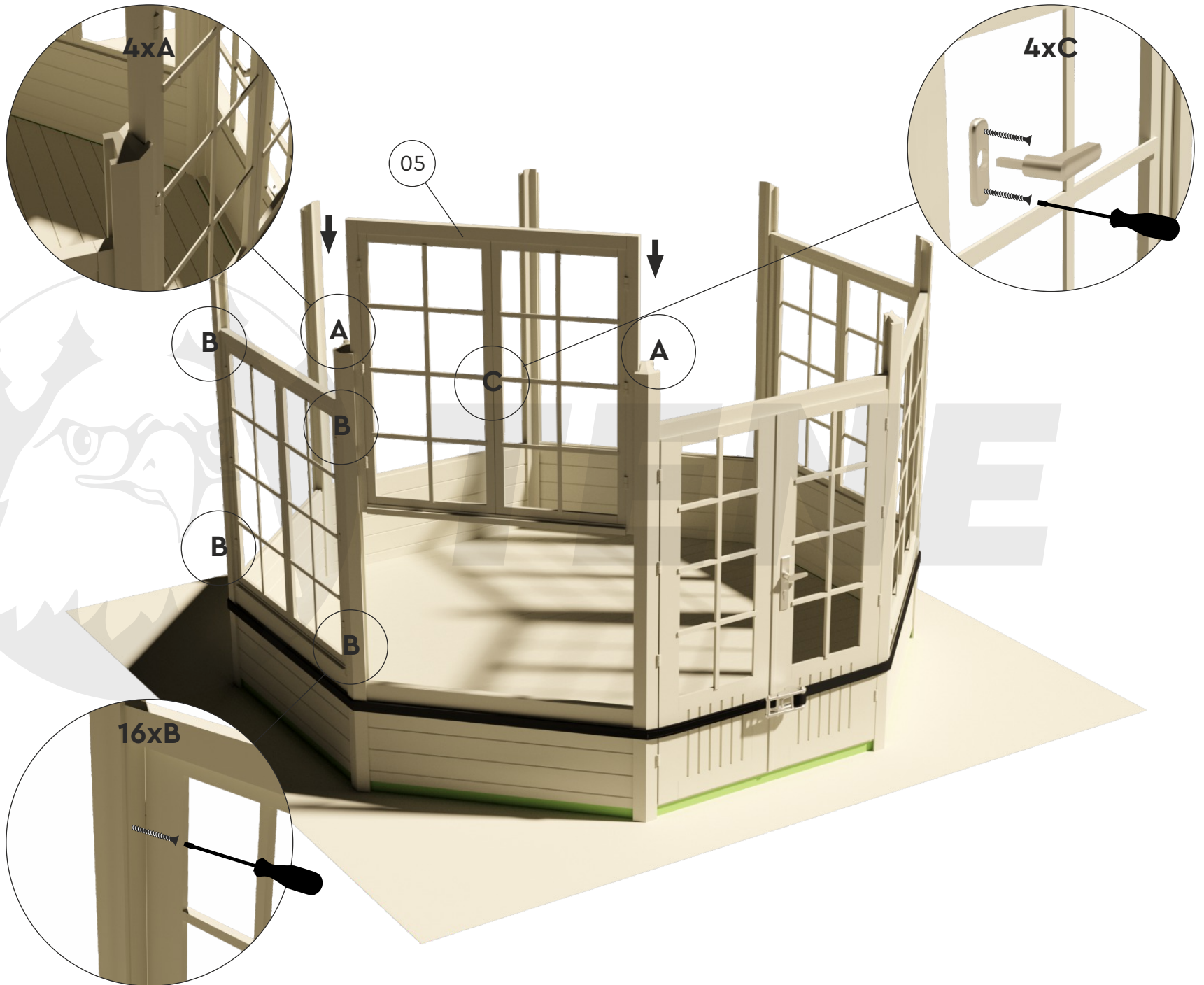

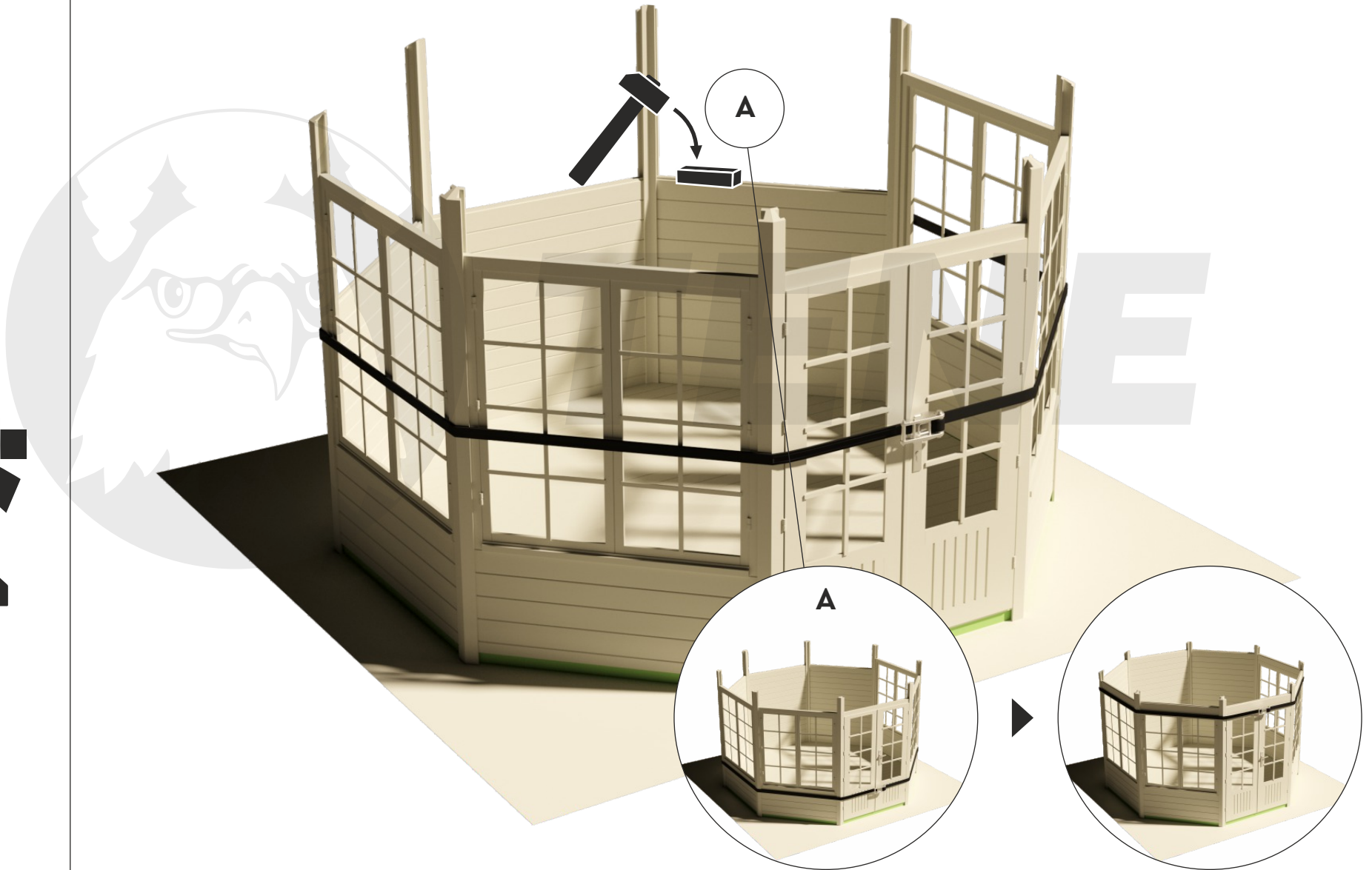
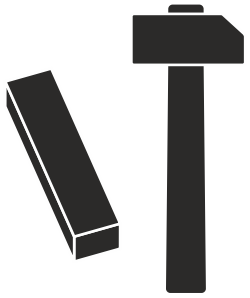
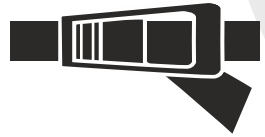

# EMMA 4F 40

09

A

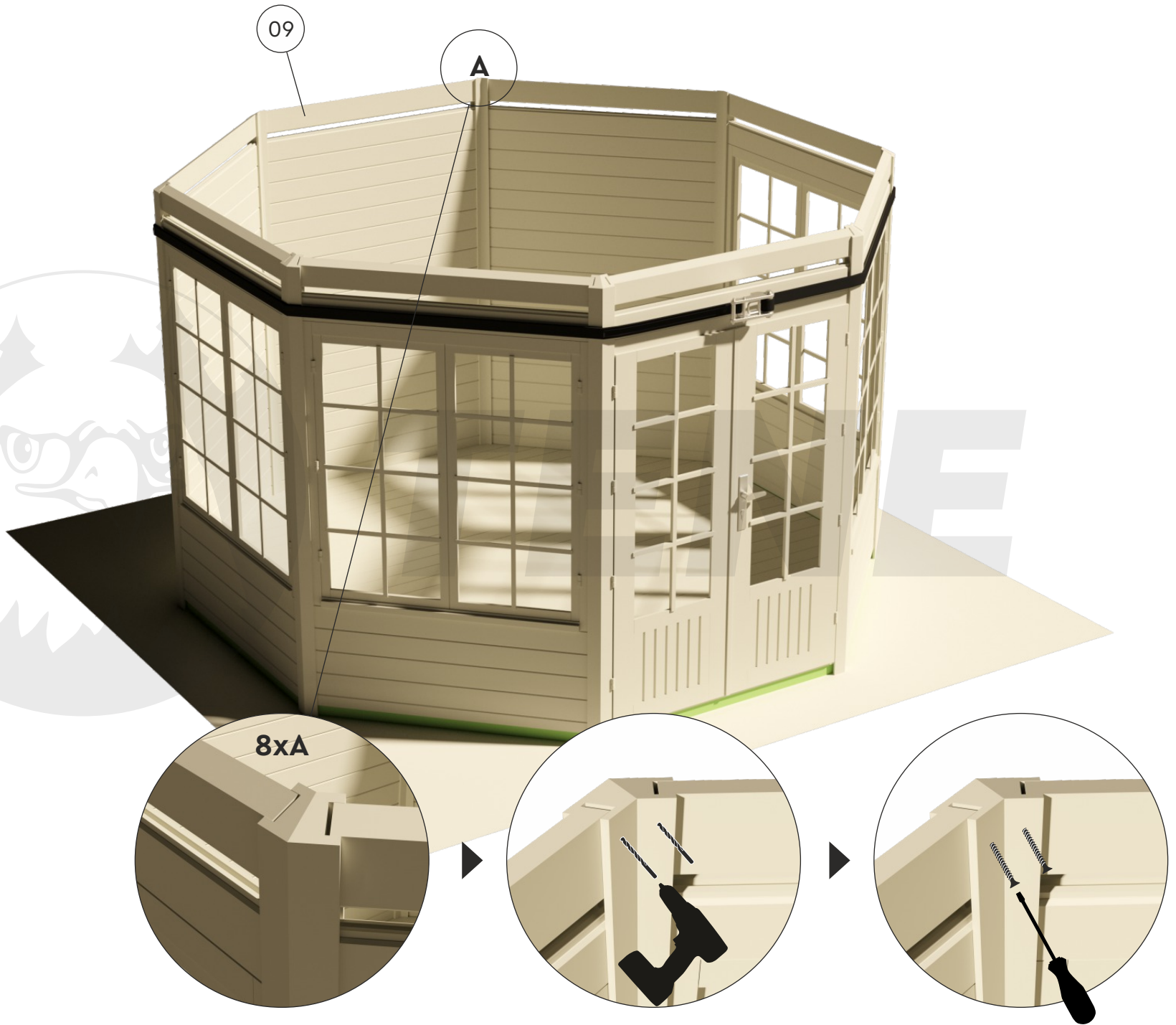
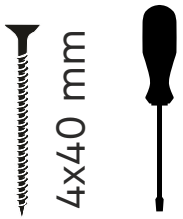
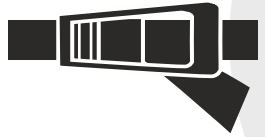

# EMMA 4F 40

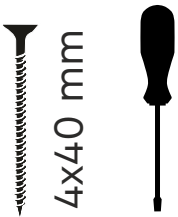
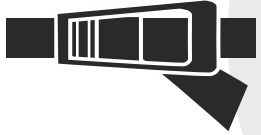
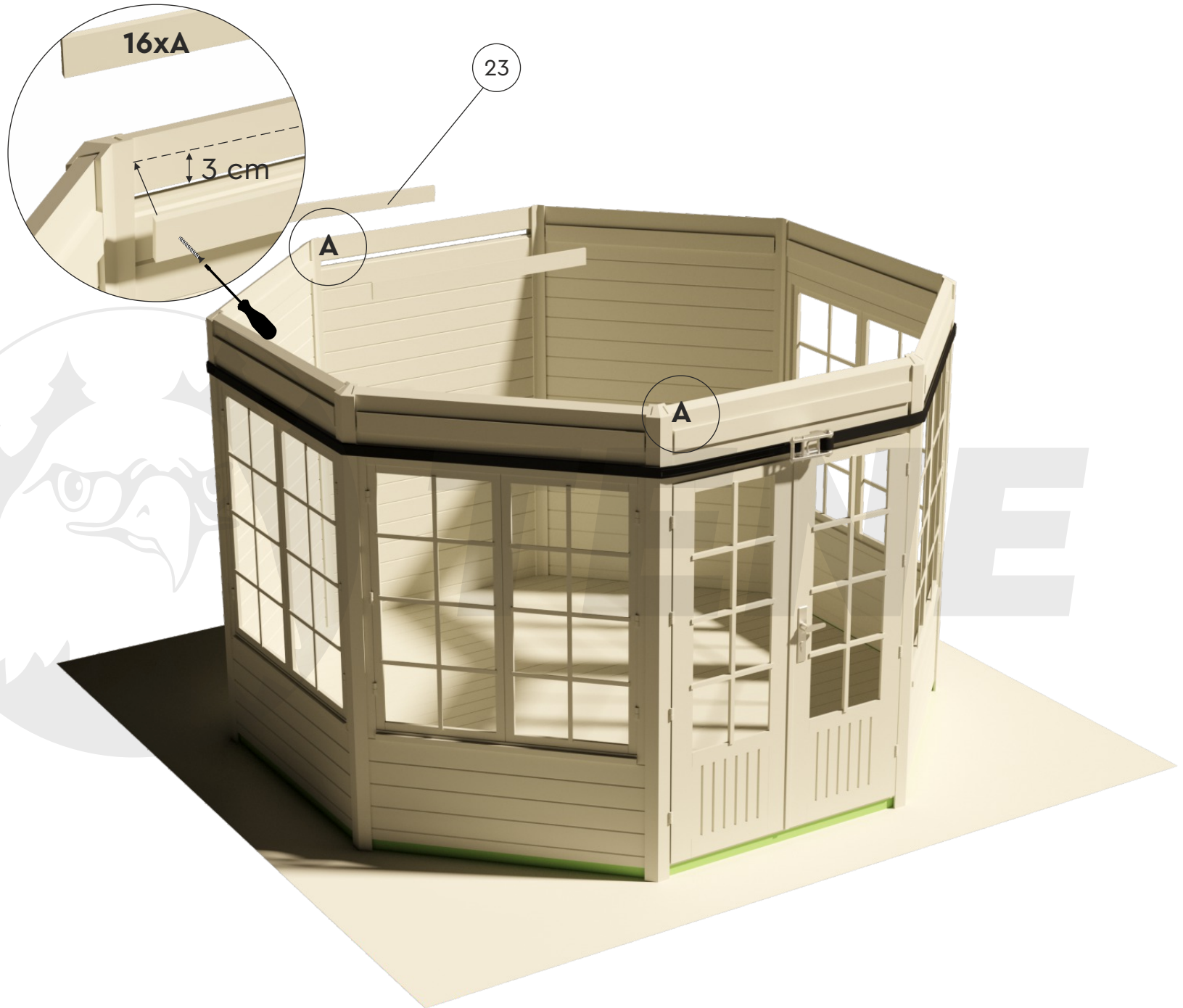



# EMMA 4F 40

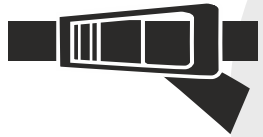

4x50 mm

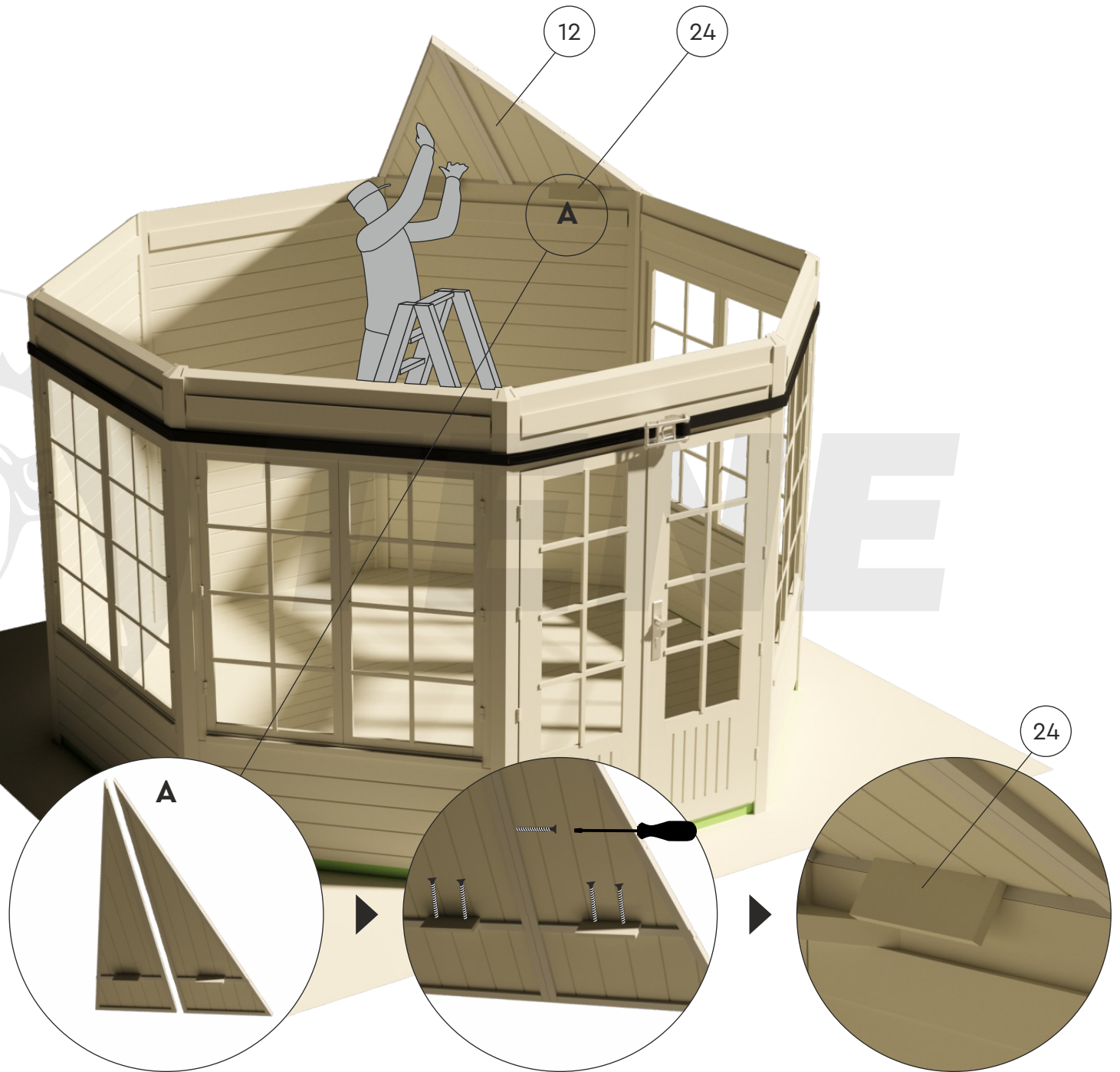
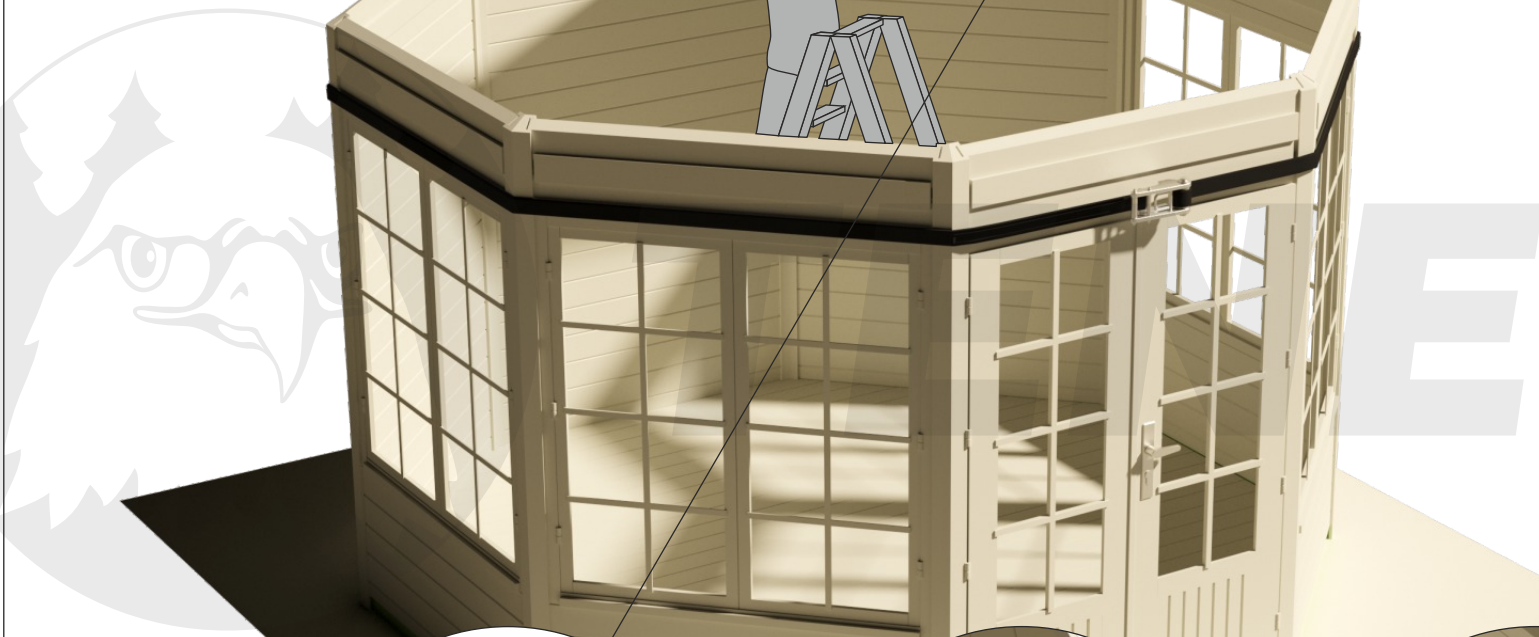



# EMMA 4F 40

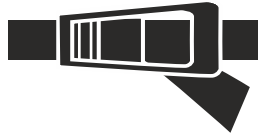

Ø 4 mm



Ø 5 mm



5x70 mm

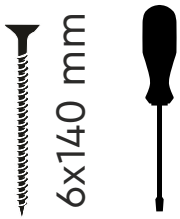

6x140 mm

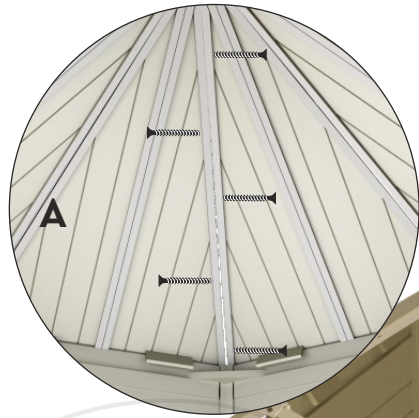

A

A



B

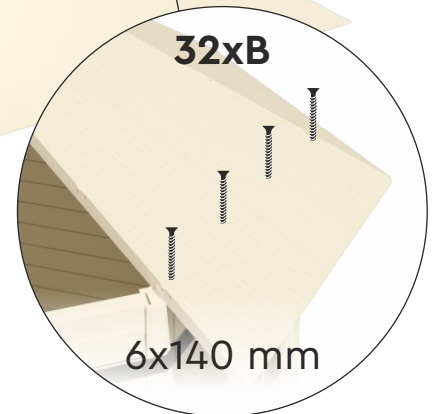
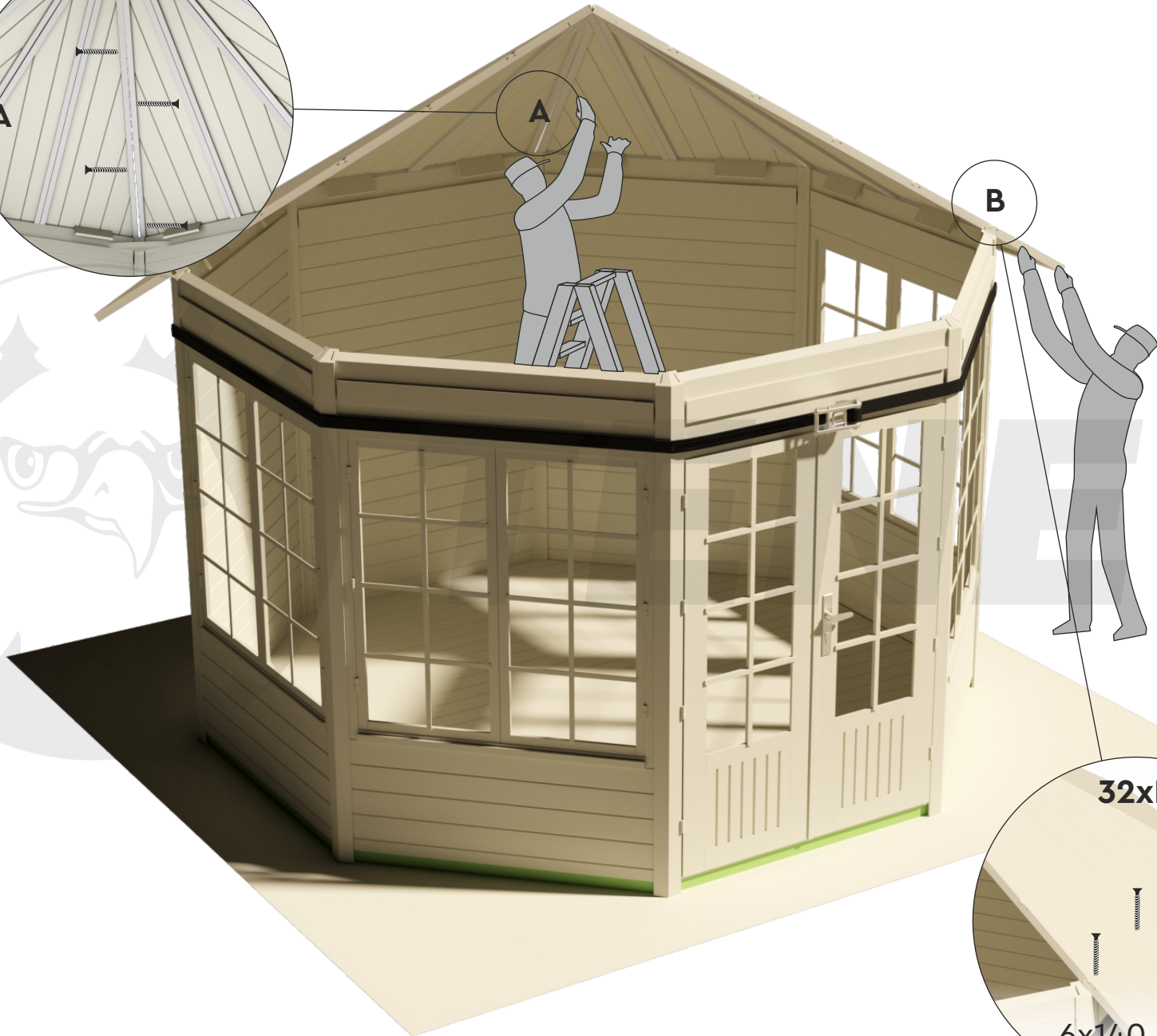

32xB

6x140 mm

# EMMA 4F 40

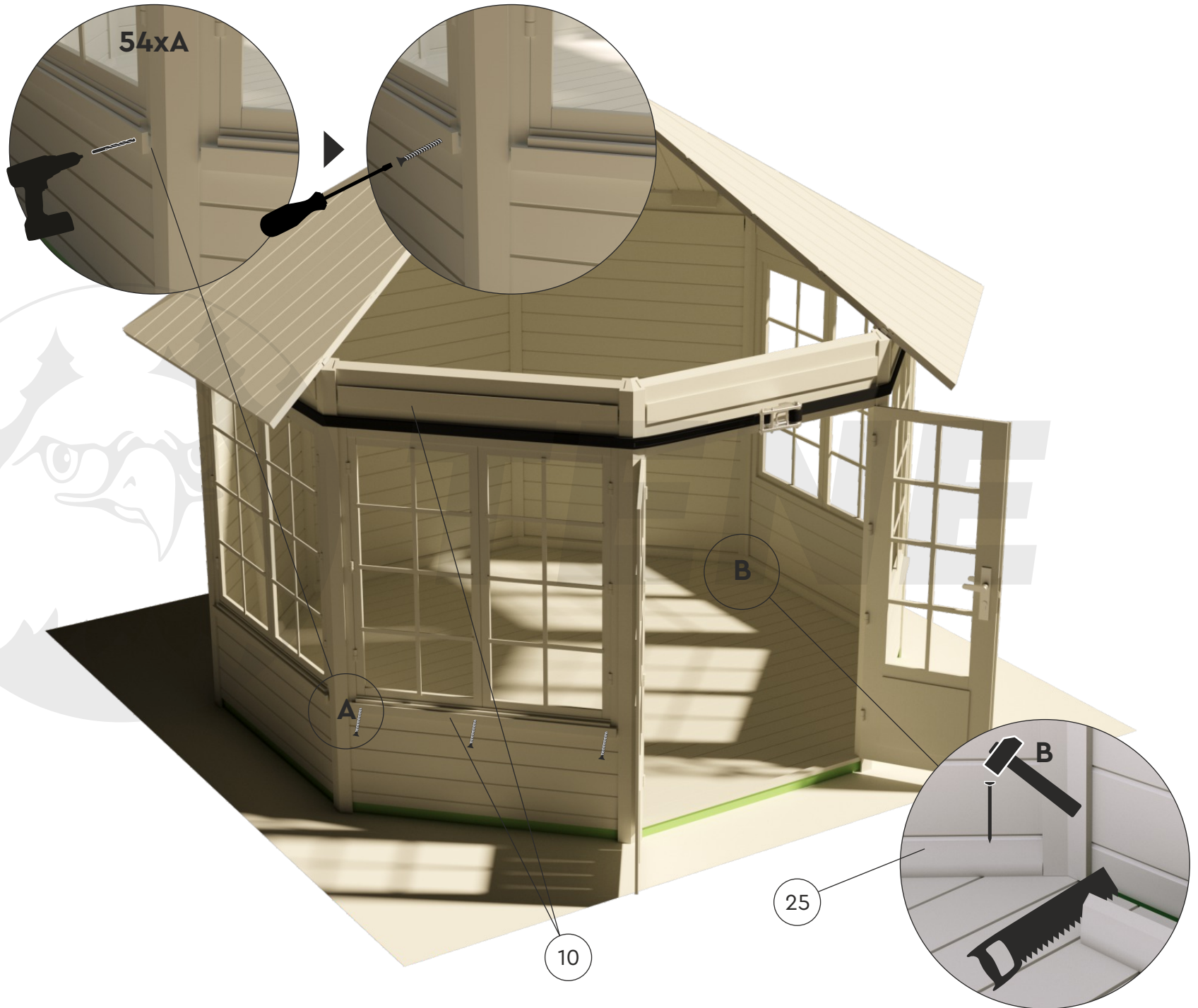
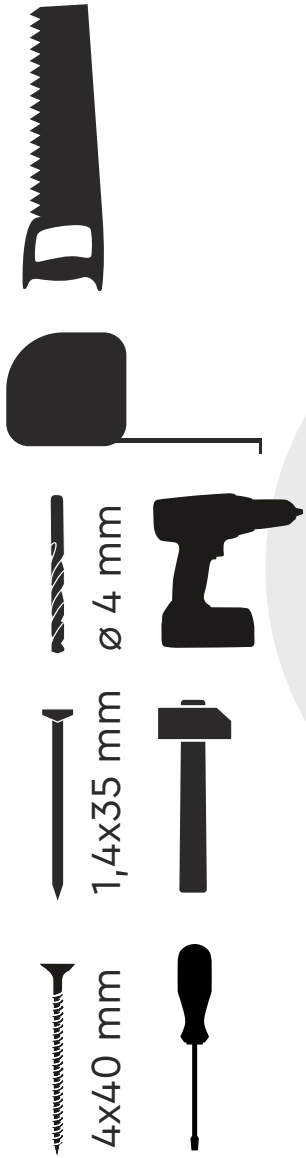

# EMMA 4F 40

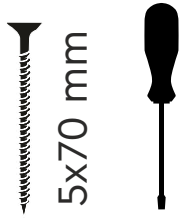
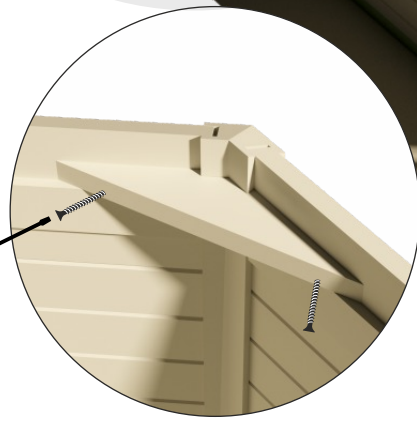
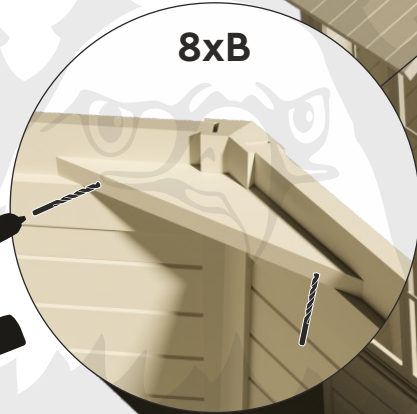
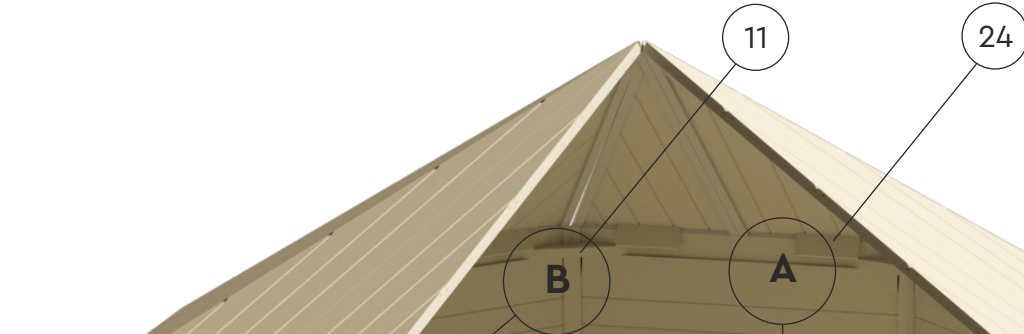



EMMA 4F 40

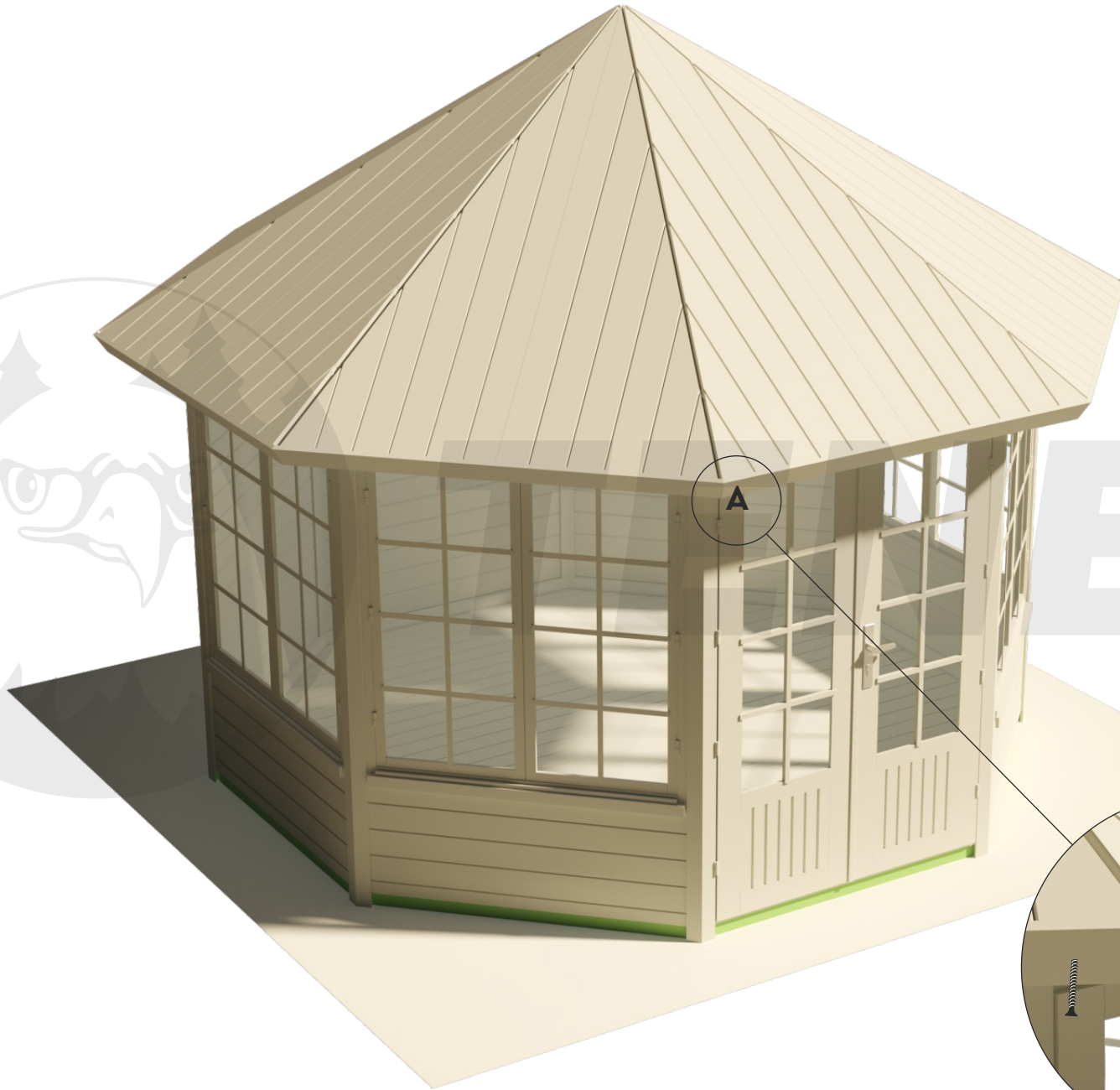

4x40 mm

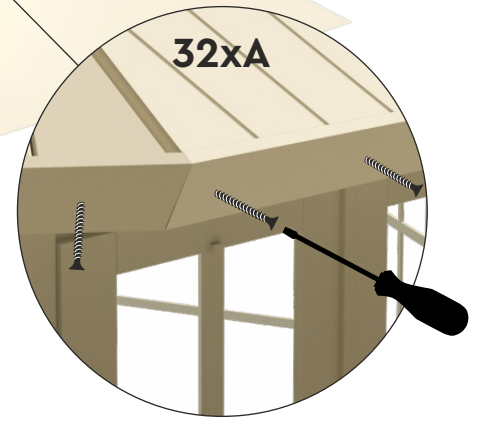

32xA

EMMA 4F 40

