

IBIZA 40

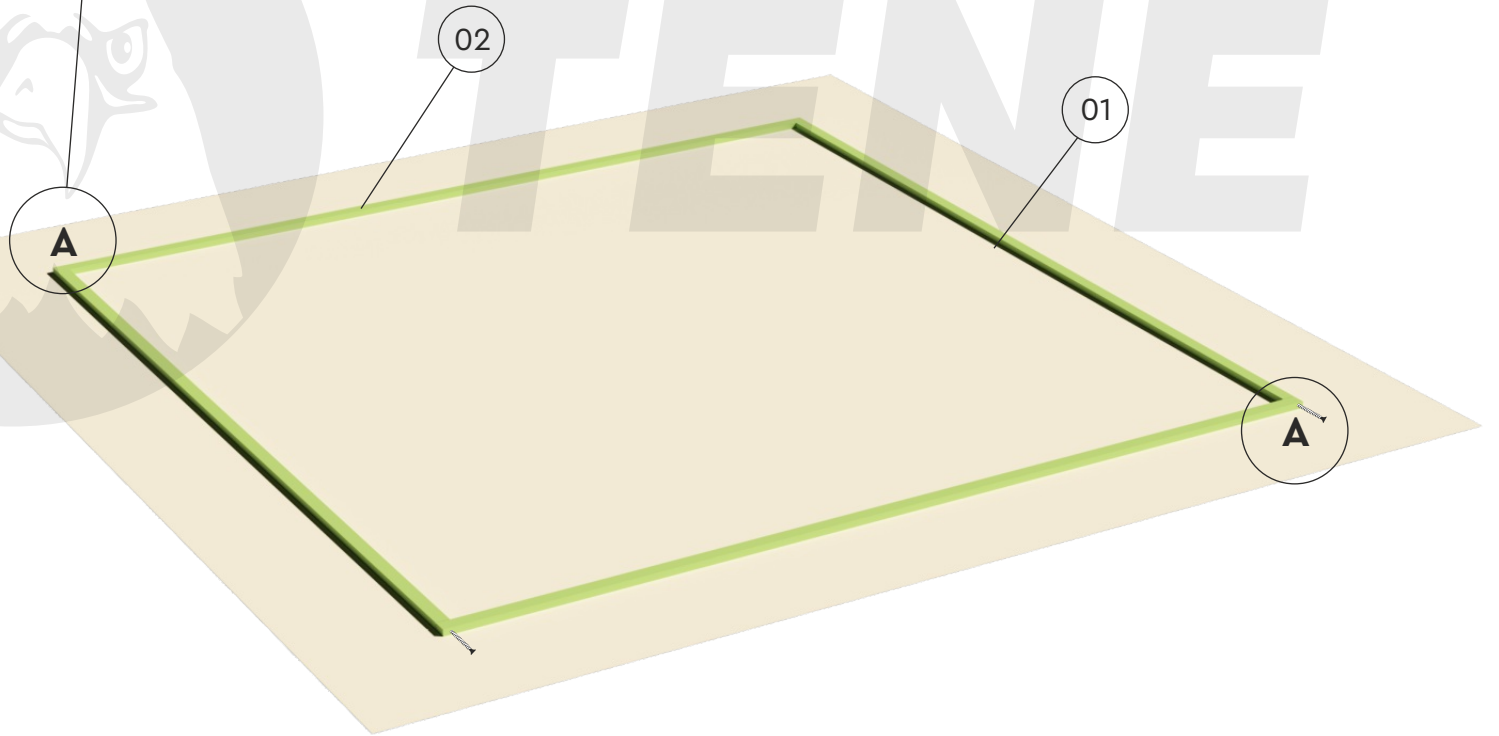

Ø 5 mm

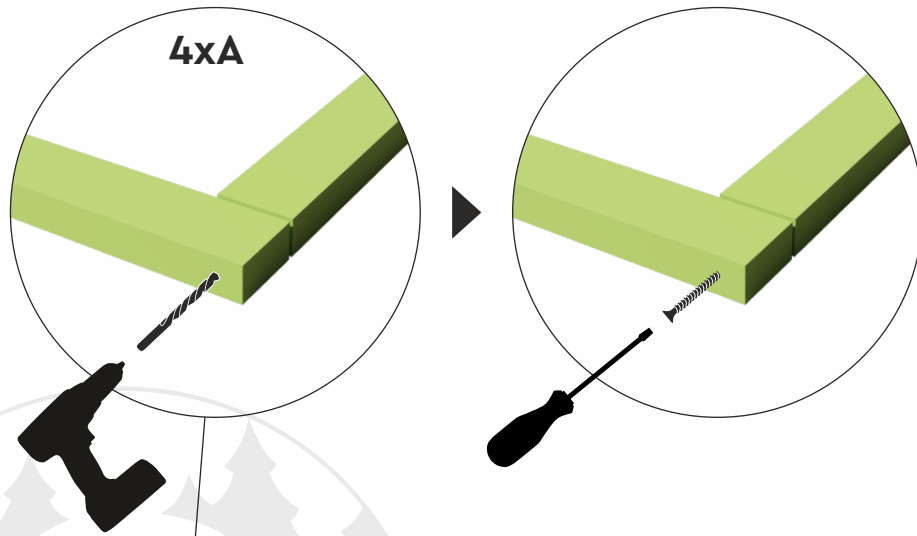
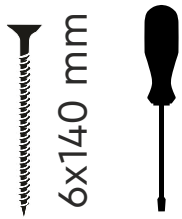

6x140 mm

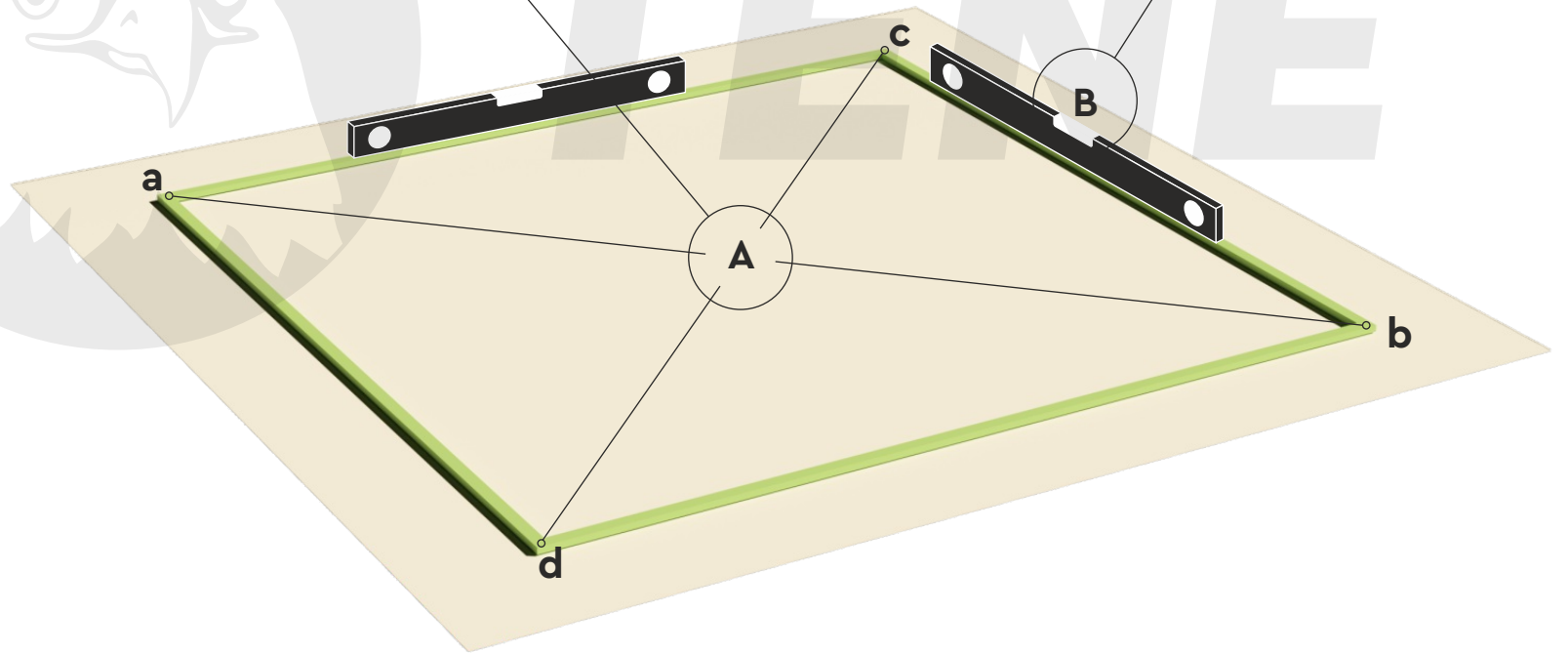
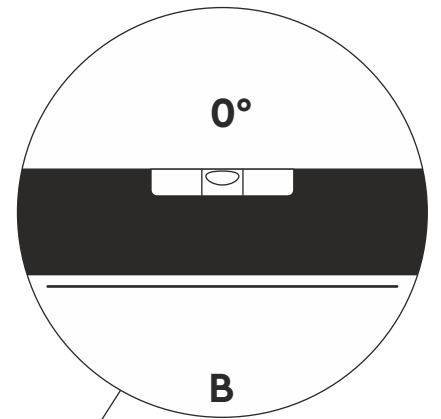
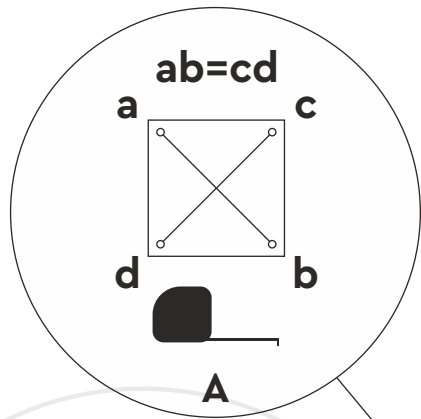

IBIZA 40

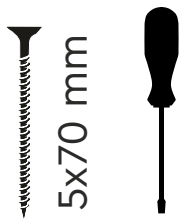
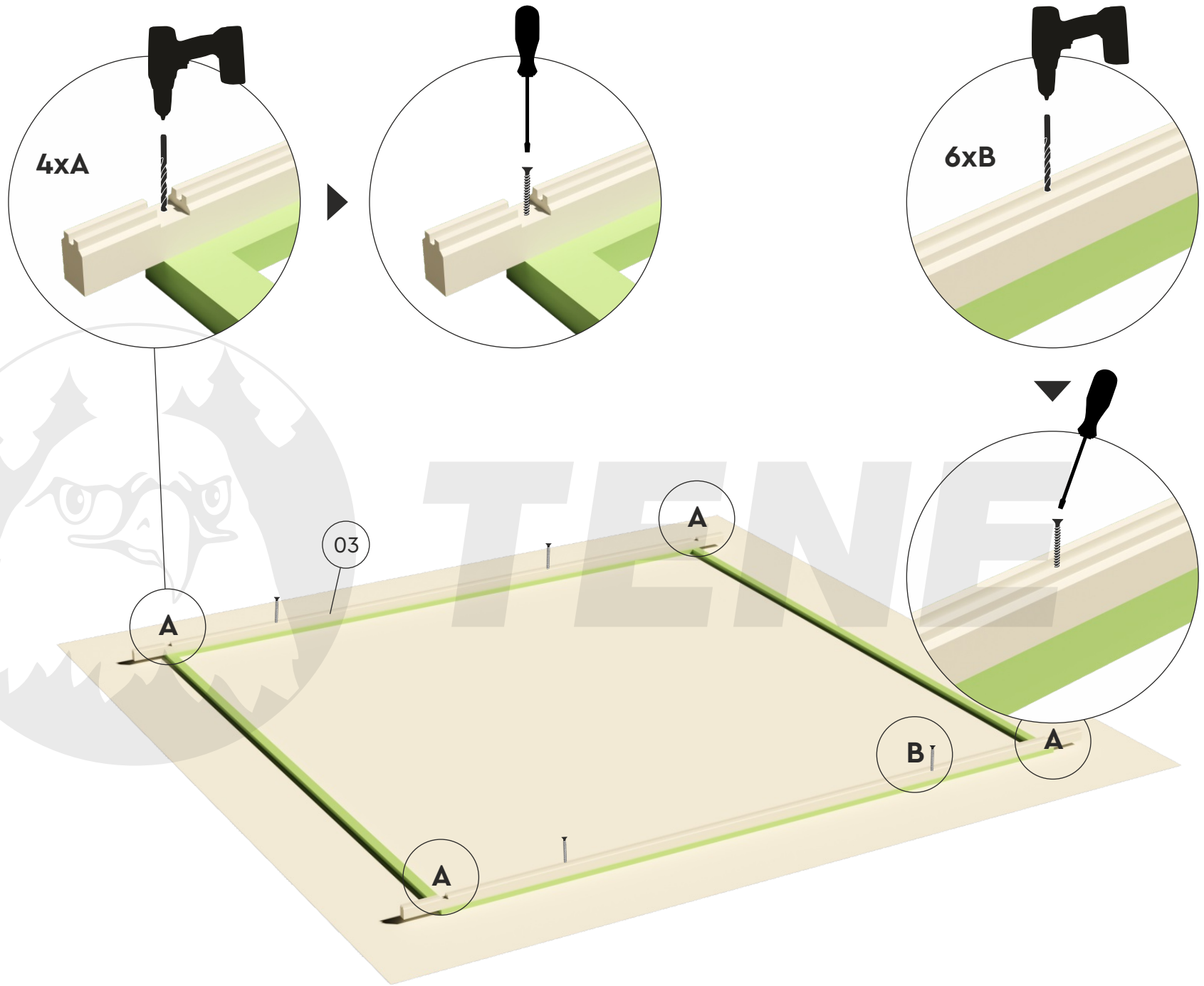

IBIZA 40

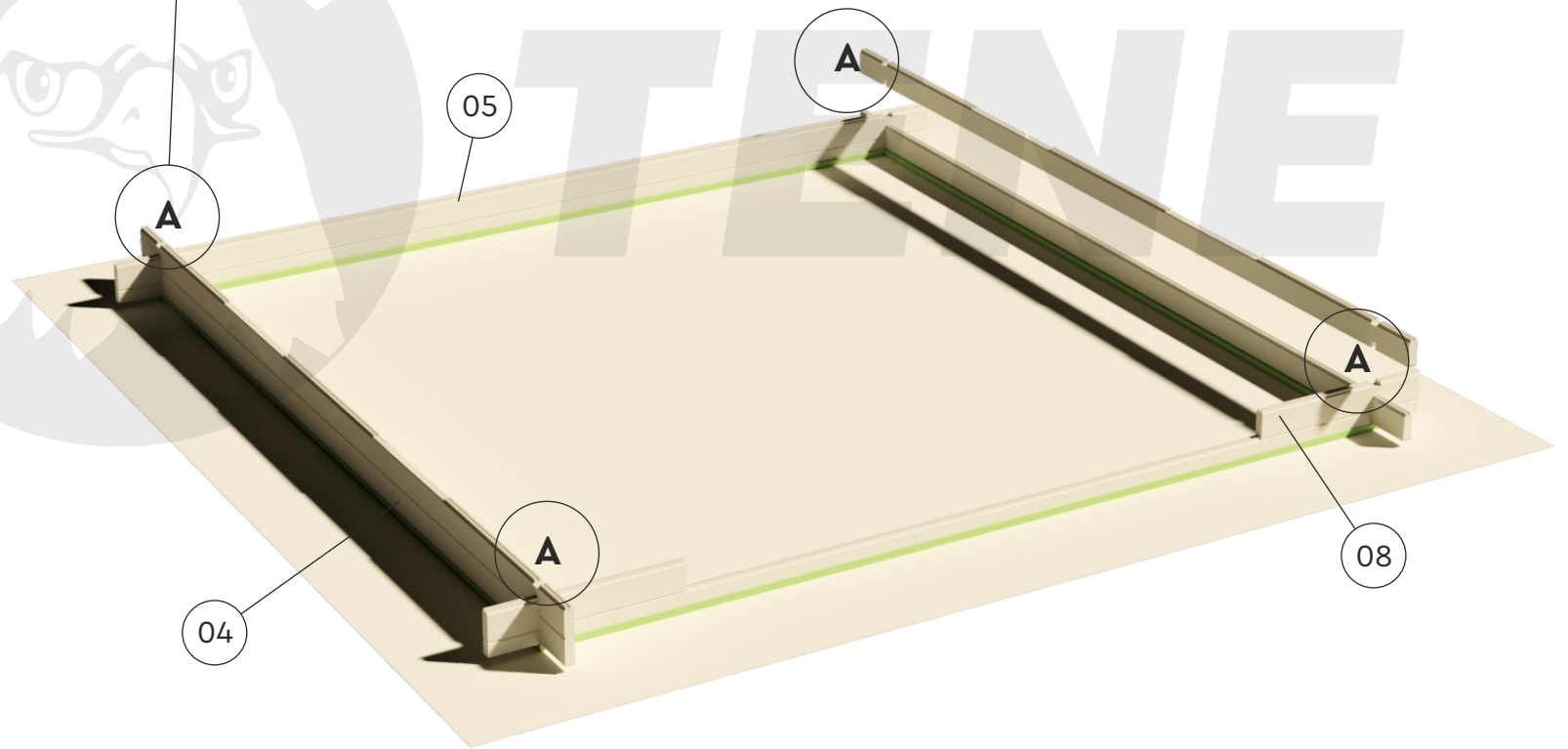
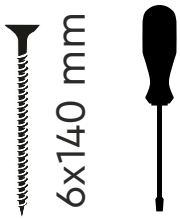
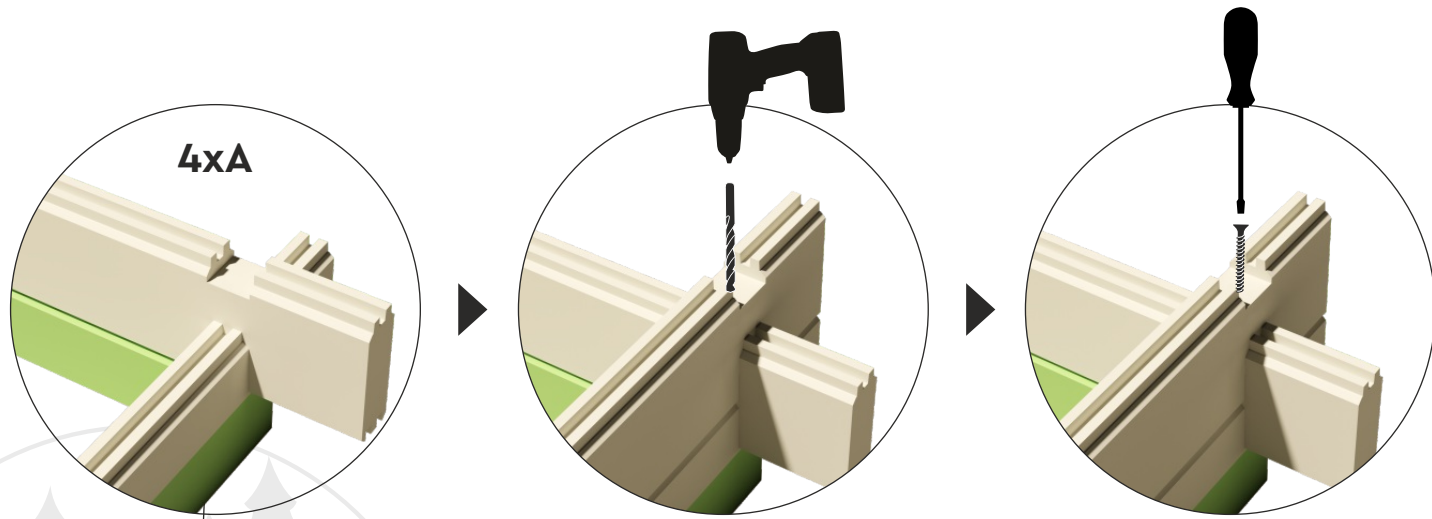

IBIZA 40



Ø 5 mm

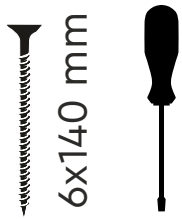

6x140 mm

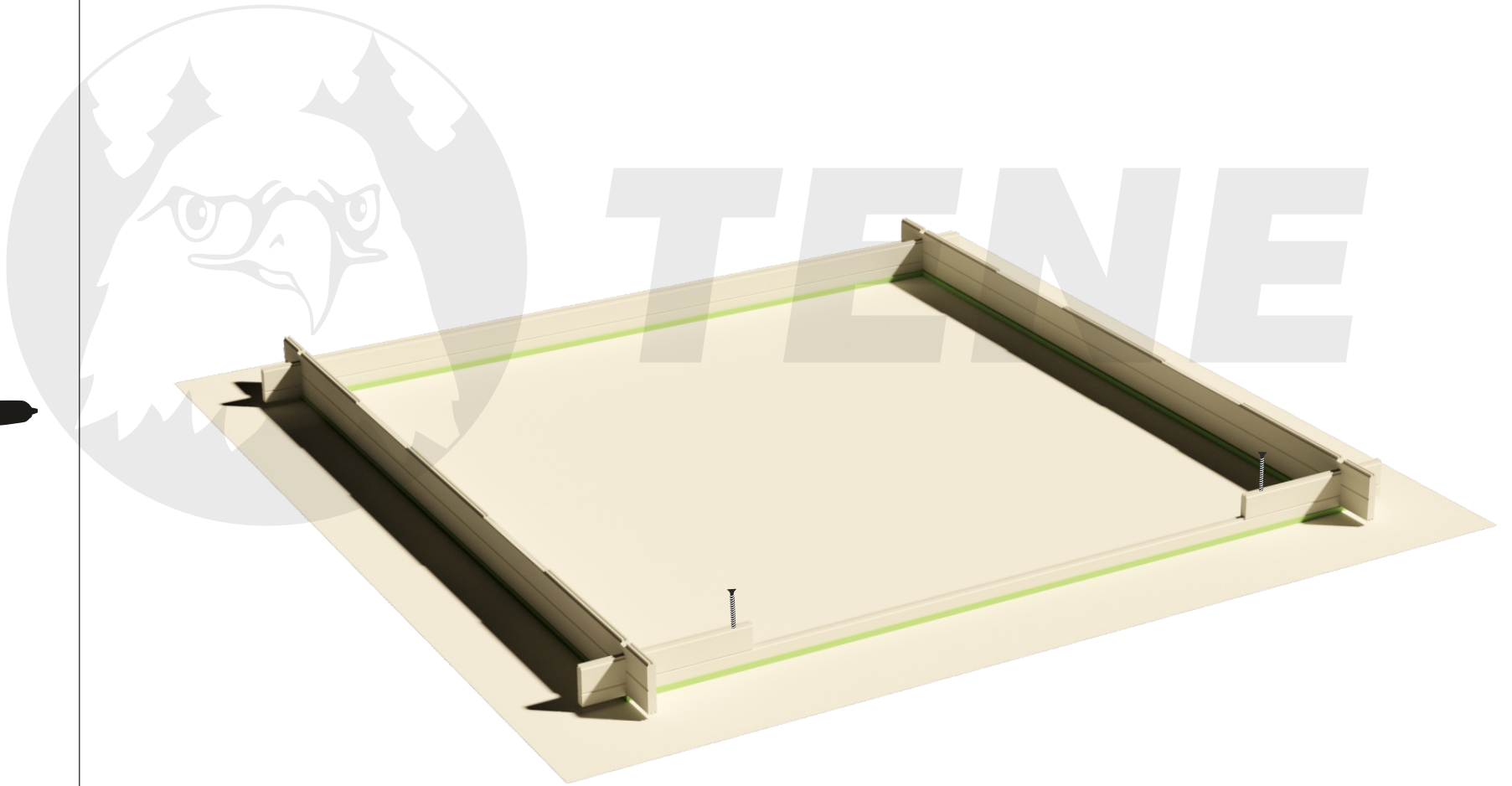

IBIZA 40

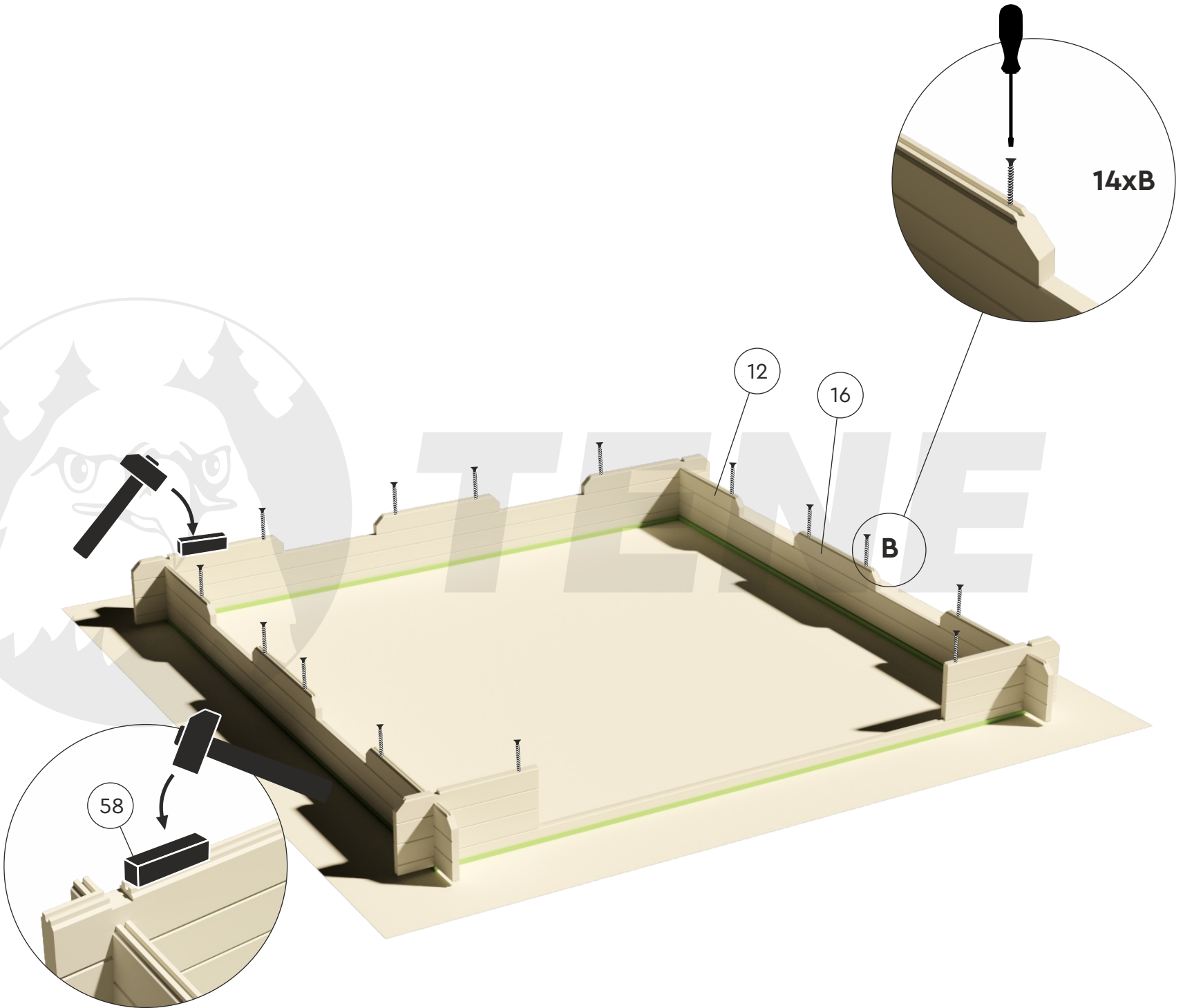

IBIZA 40

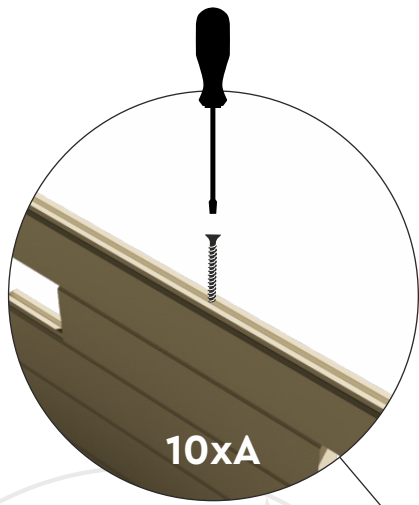

A

A 3D perspective view of a rectangular wooden structure, possibly a planter box or a small enclosure. The structure is made of light-colored wooden planks. A green line is drawn along the bottom edge of the structure. A circular callout labeled 'A' points to a specific location on the top edge of the structure. Other callouts labeled '09', '07', and '10' point to different parts of the structure. Small arrows indicate the direction of assembly for various components.

09

07

10



∅ 5 mm



6x140 mm



IBIZA 40

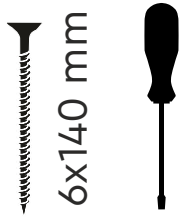
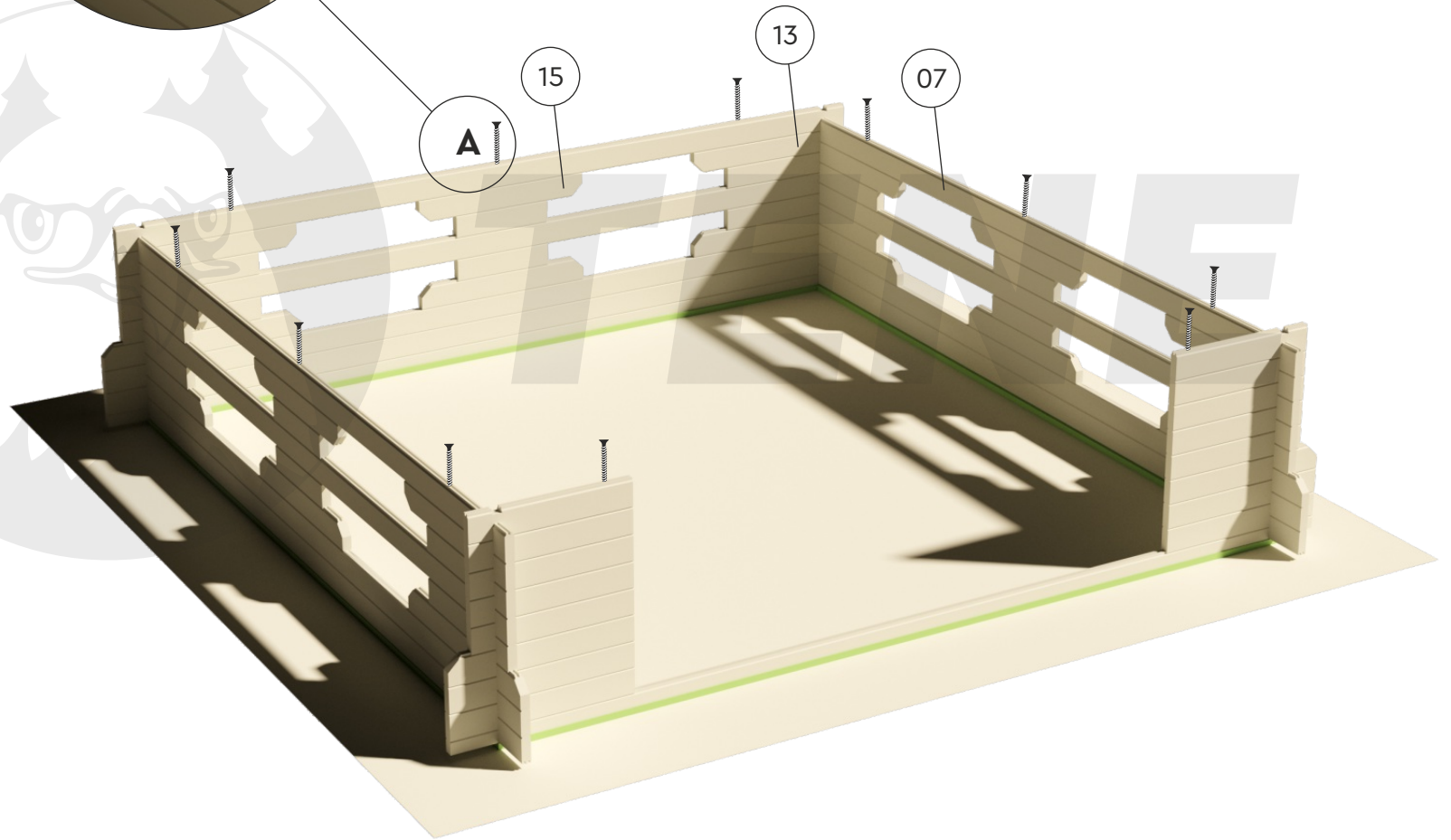
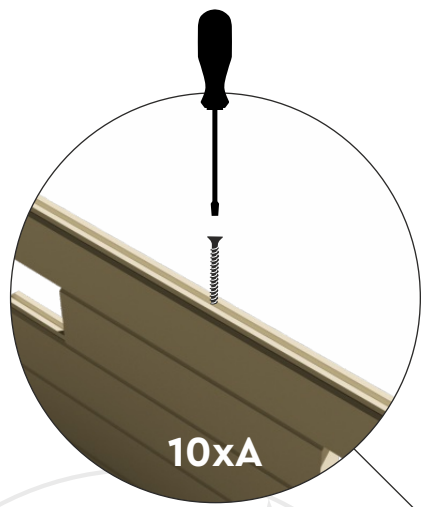

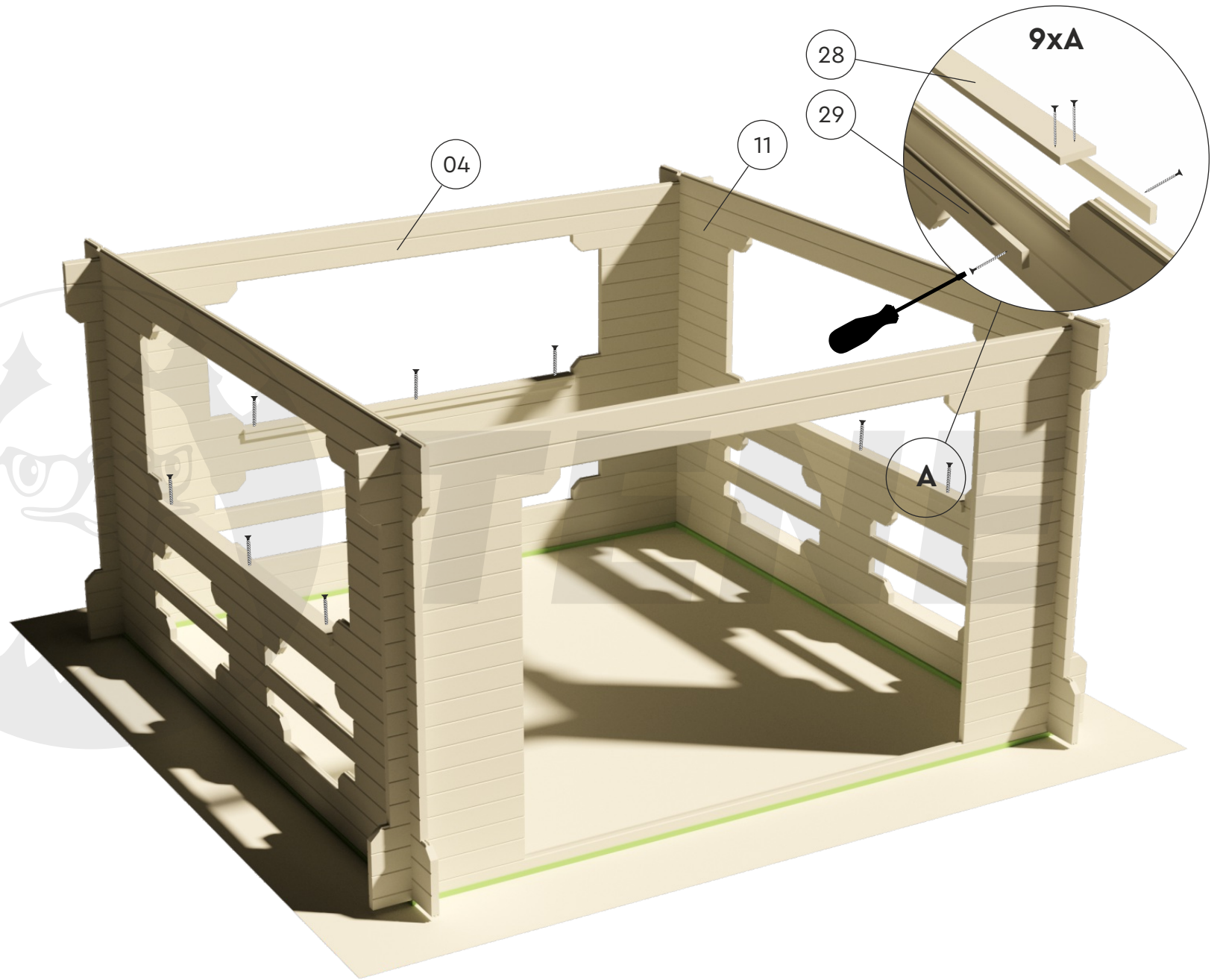

IBIZA 40

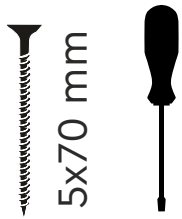
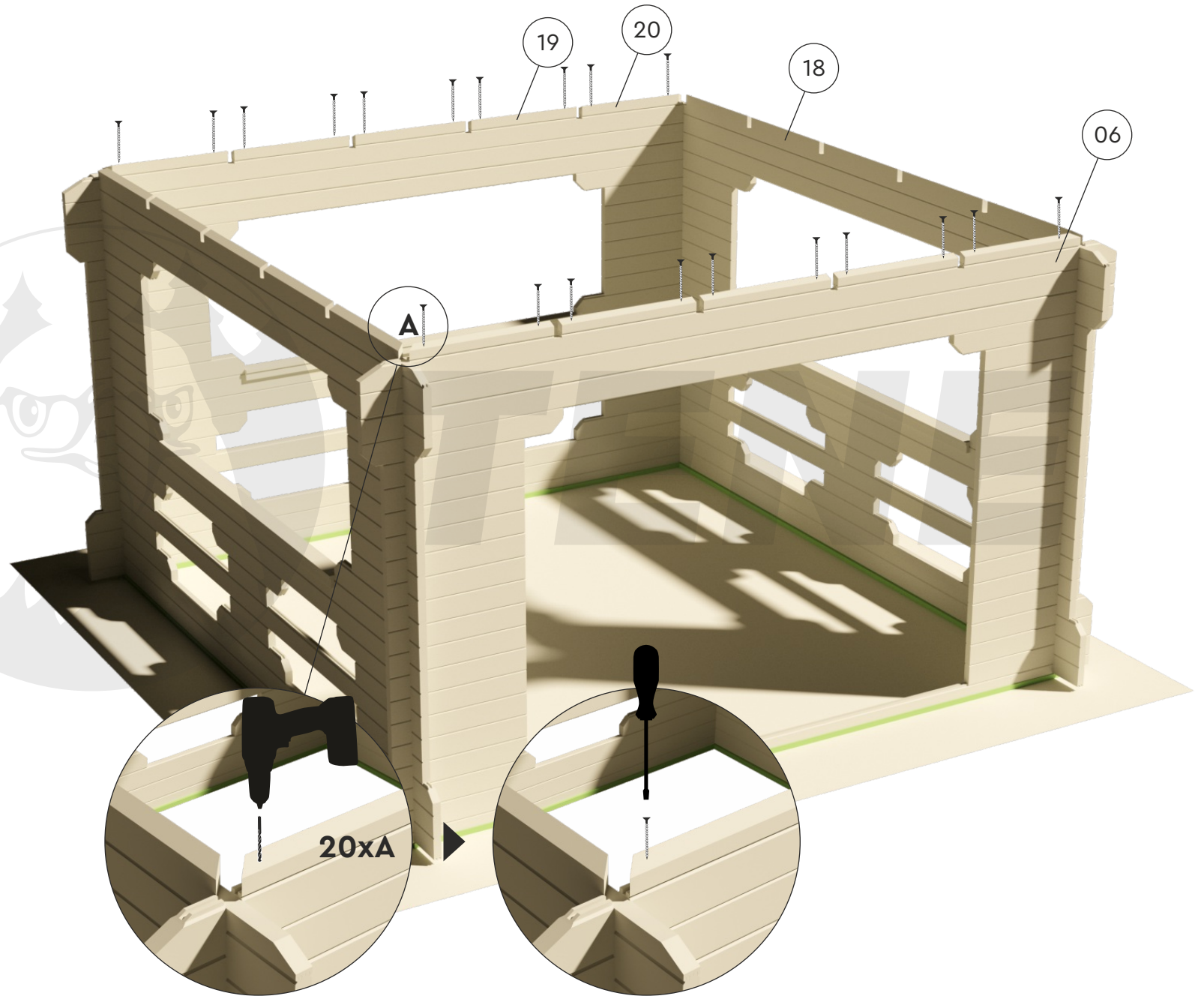

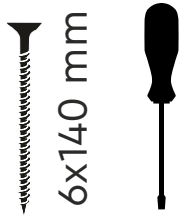
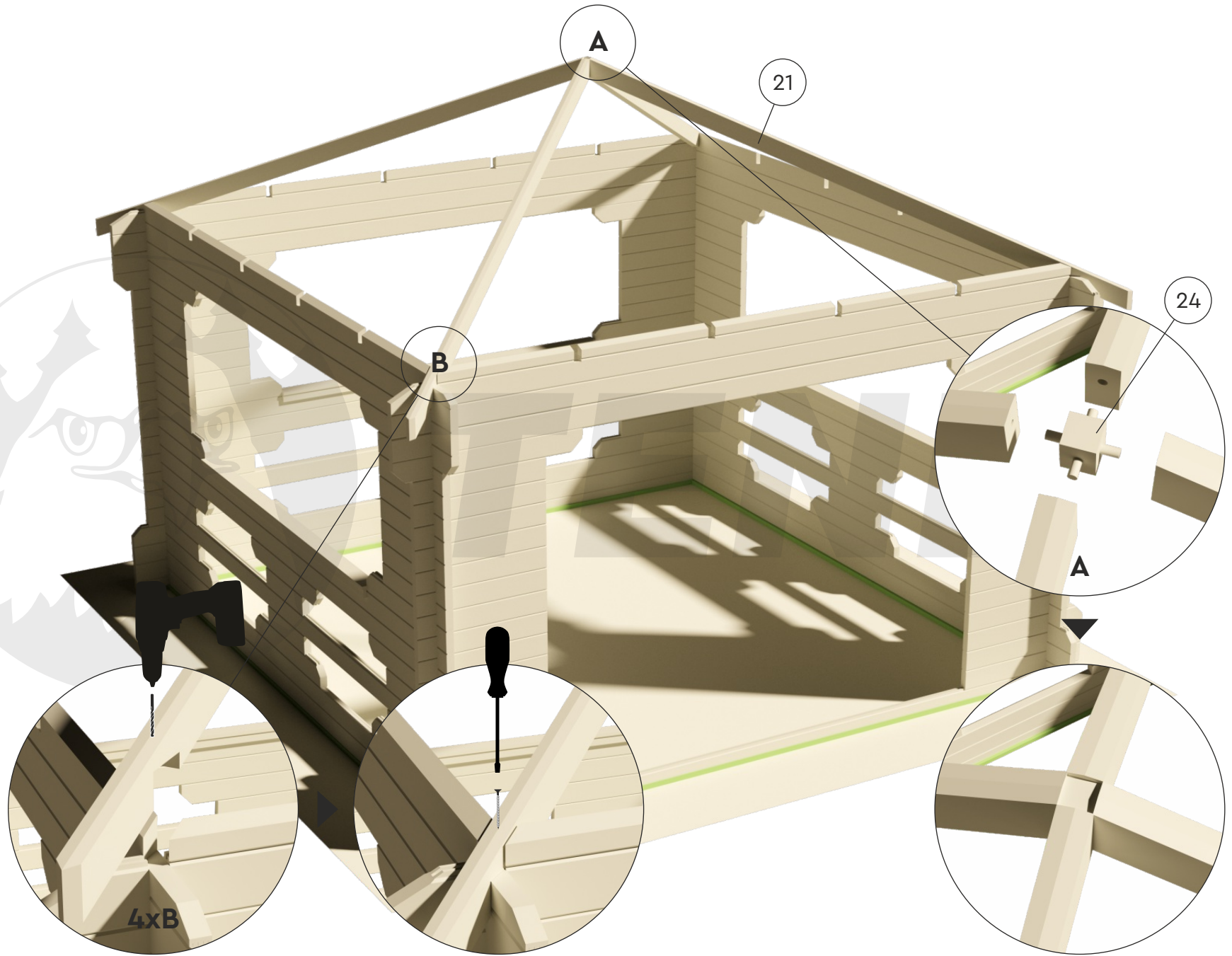



ø 5 mm



ø 4 mm



6x140 mm



5x70 mm

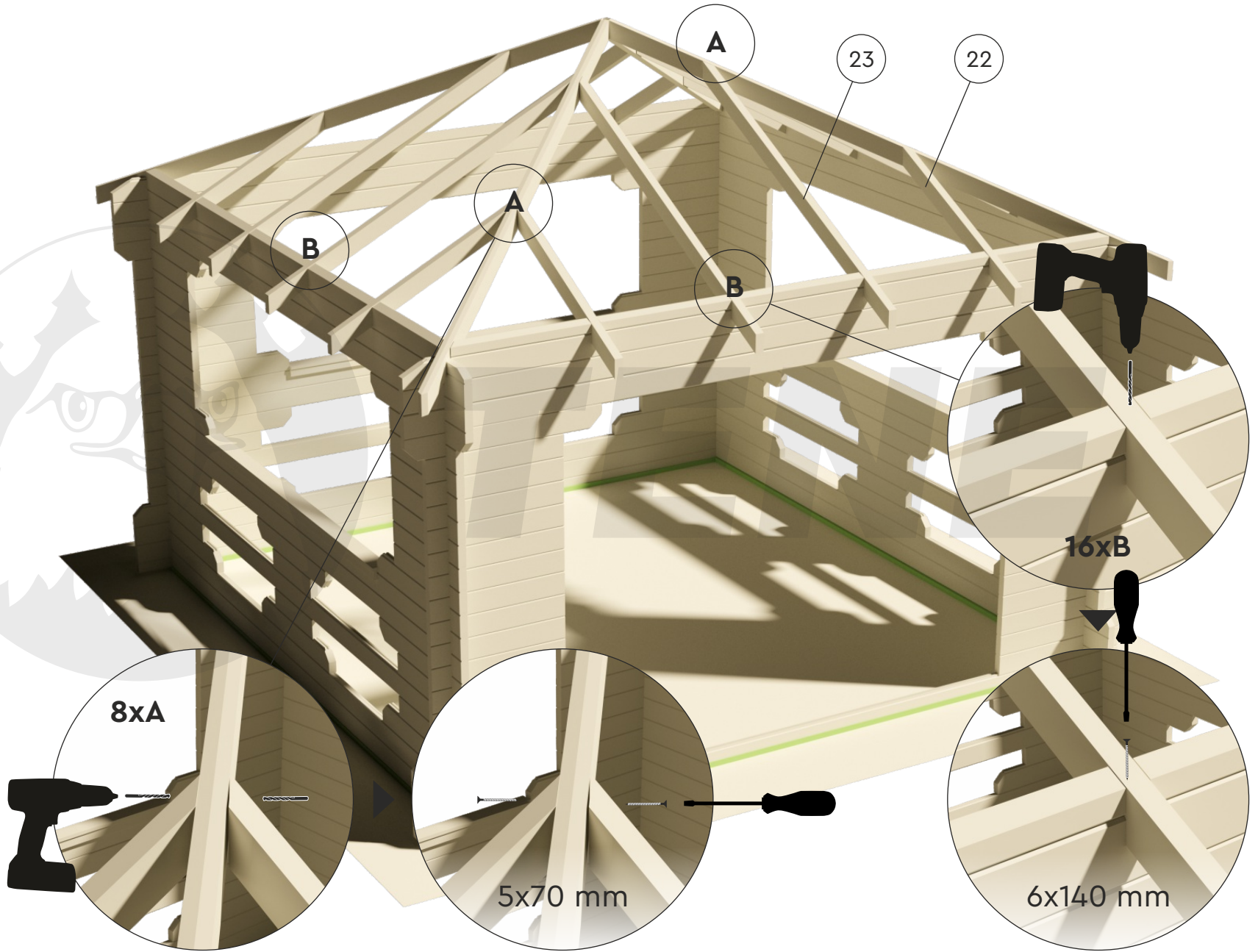

IBIZA 40

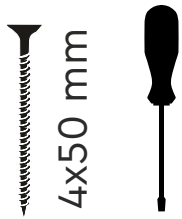
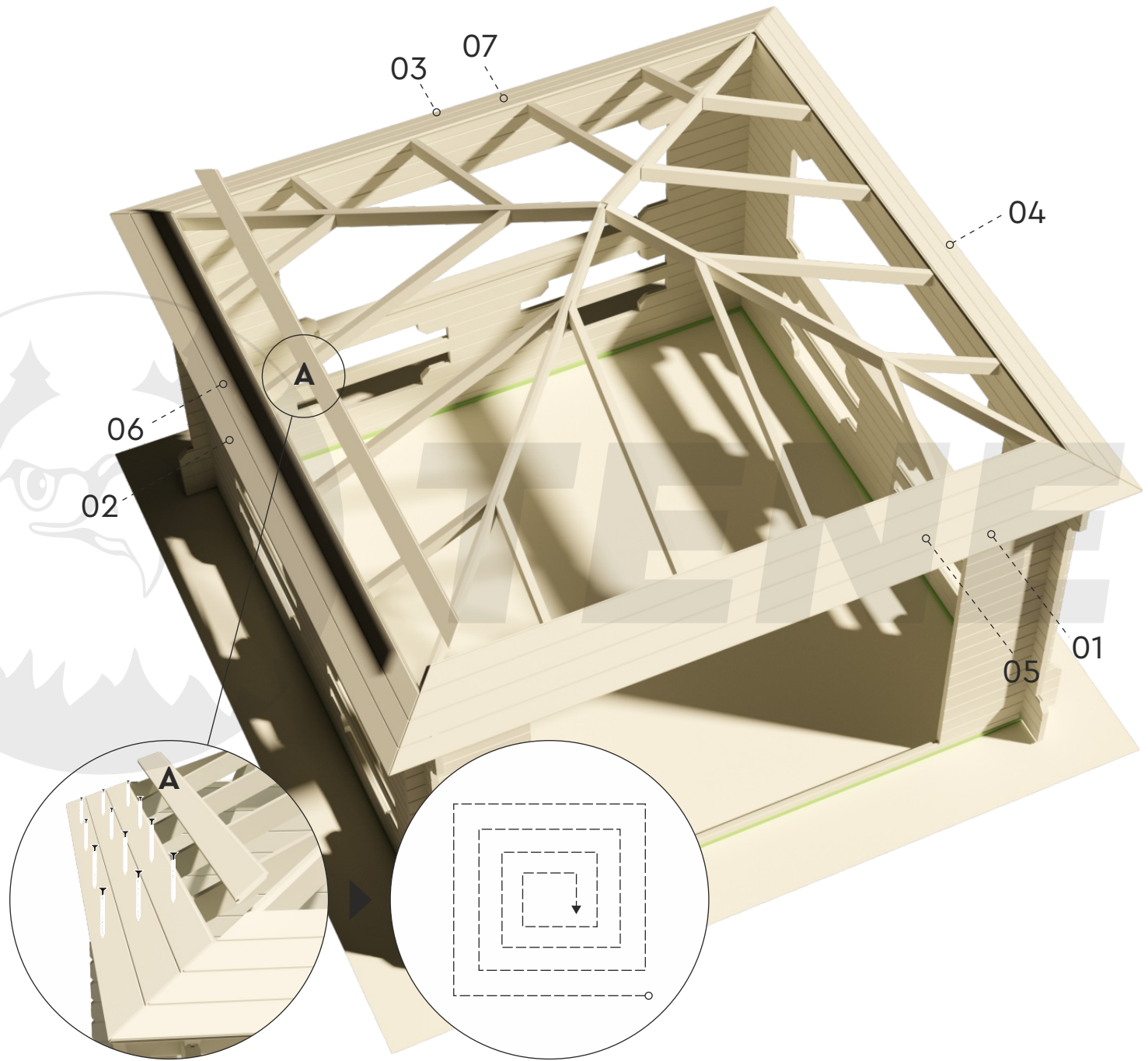

IBIZA 40

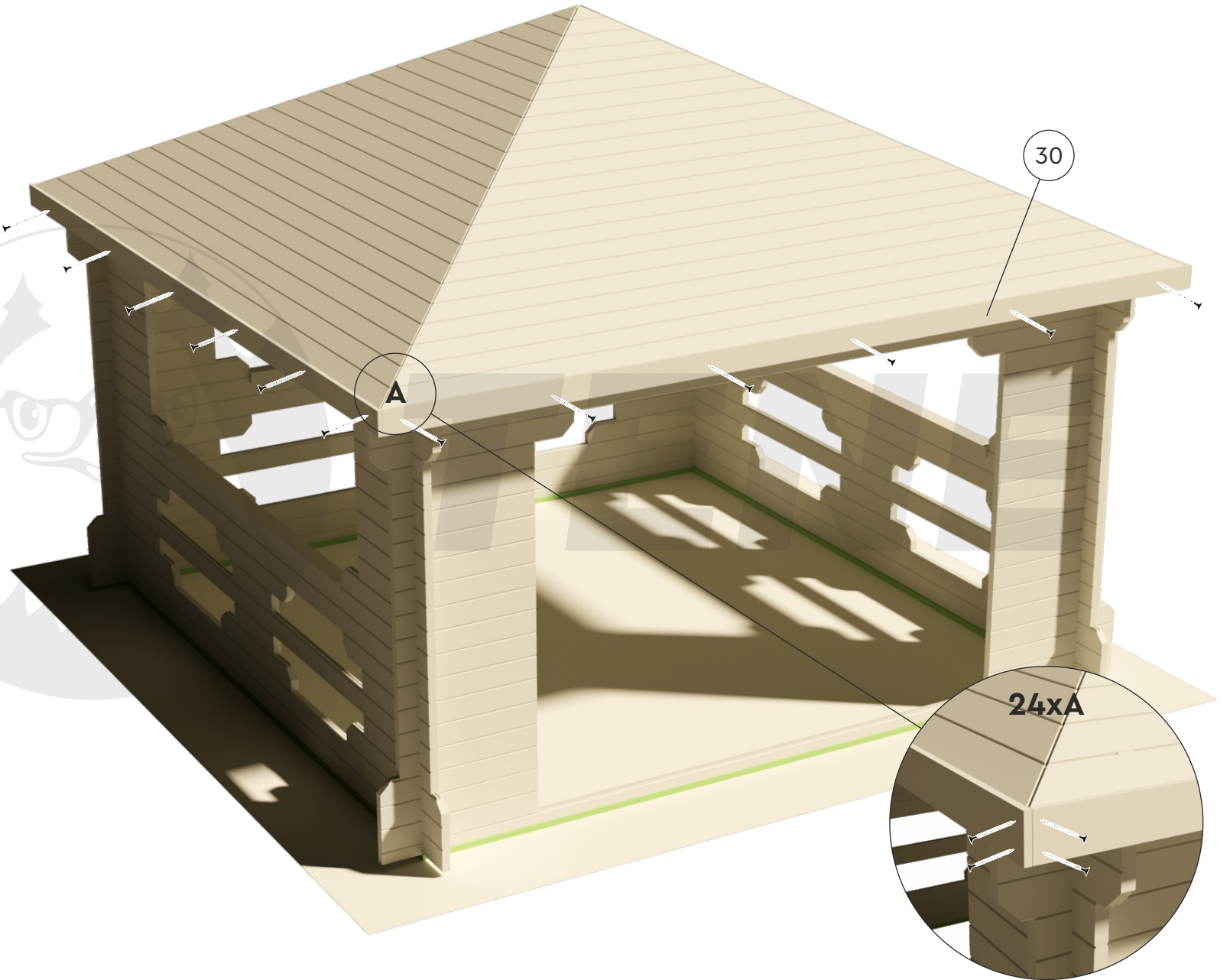

Ø 3 mm

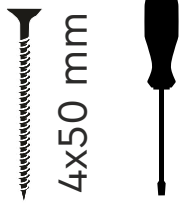

4x50 mm

