

LOUISE 4F 40

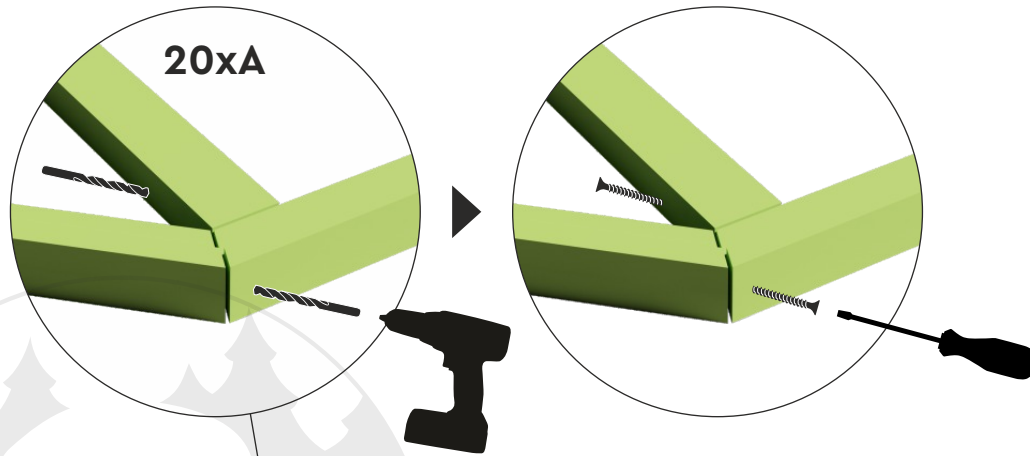

∅ 5 mm

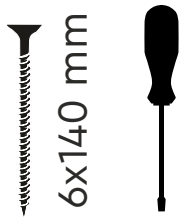

6x140 mm

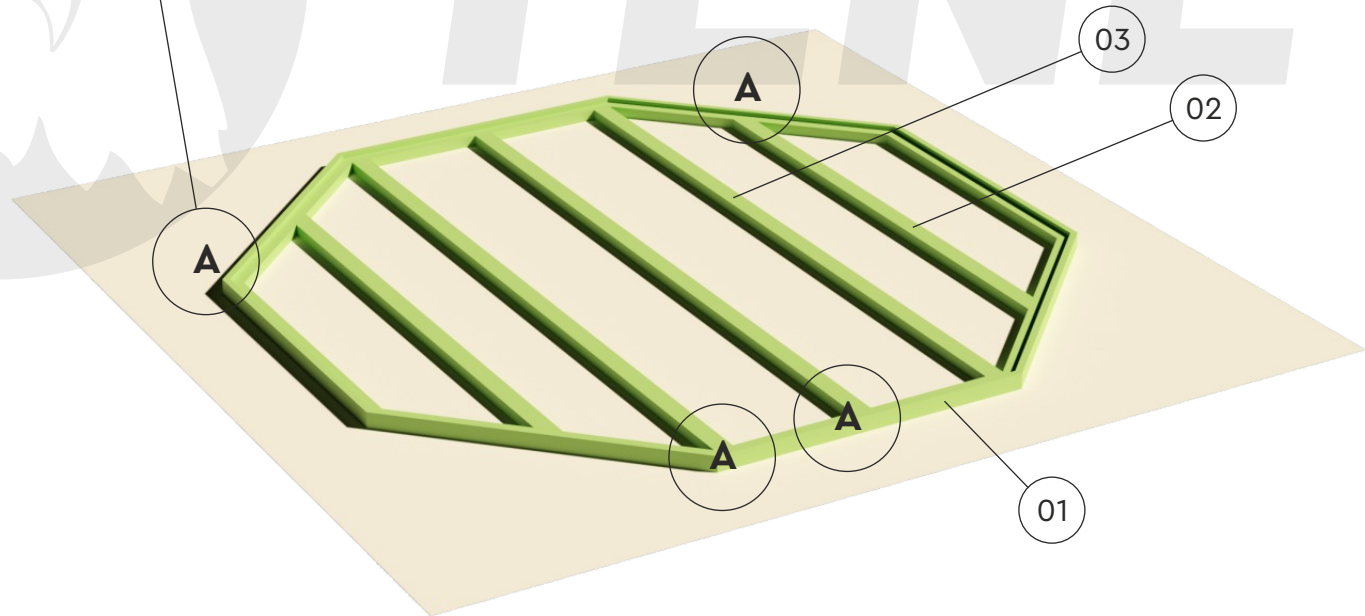

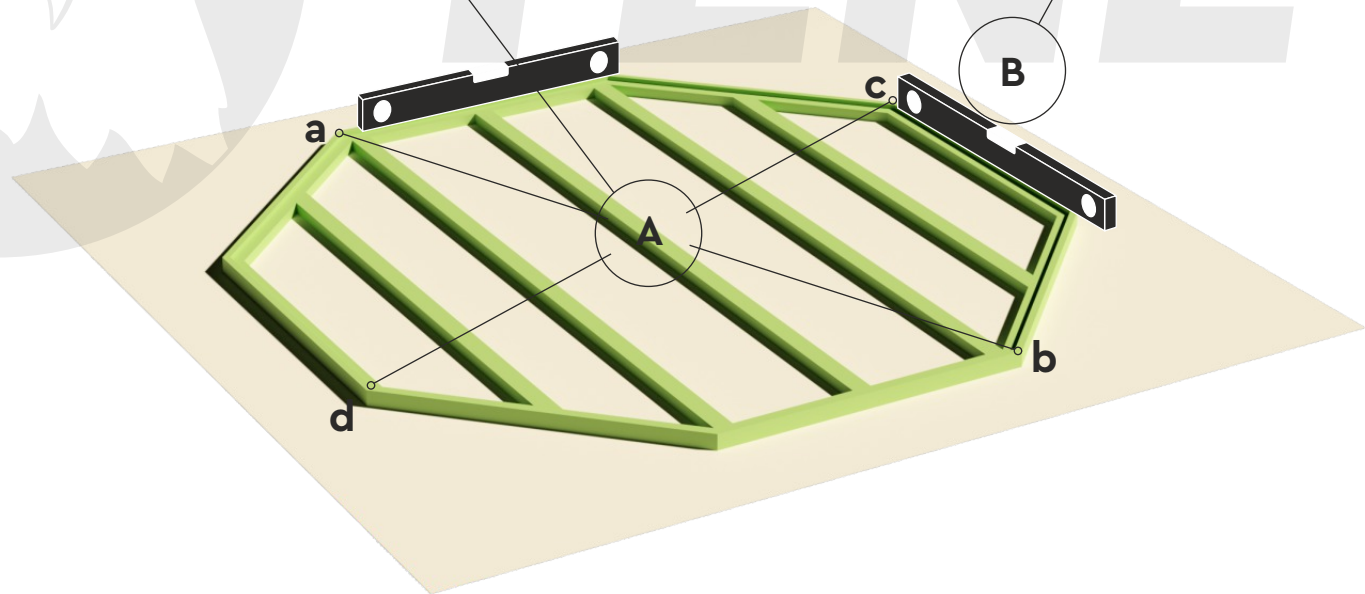
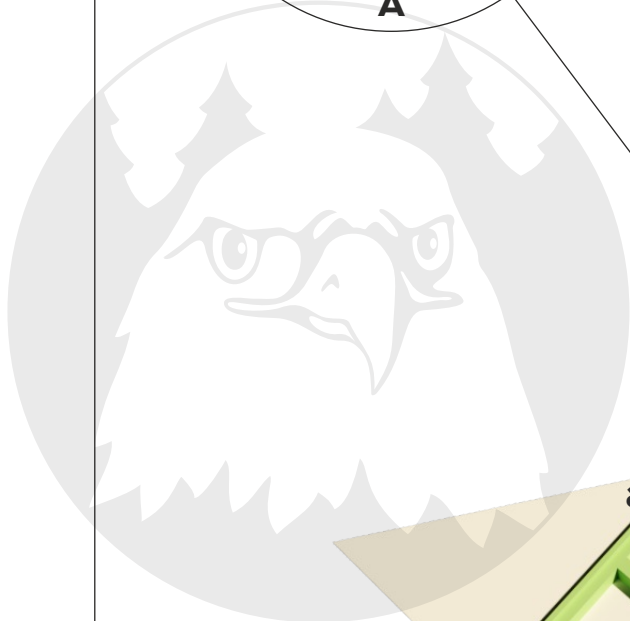
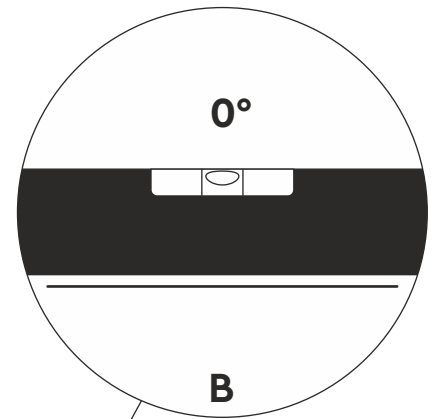
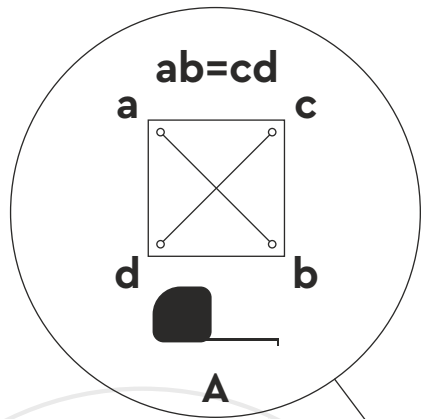

LOUISE 4F 40

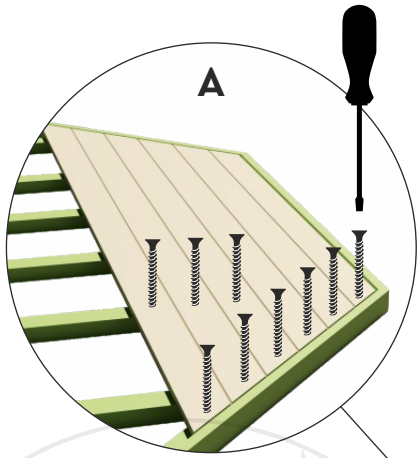

TENE

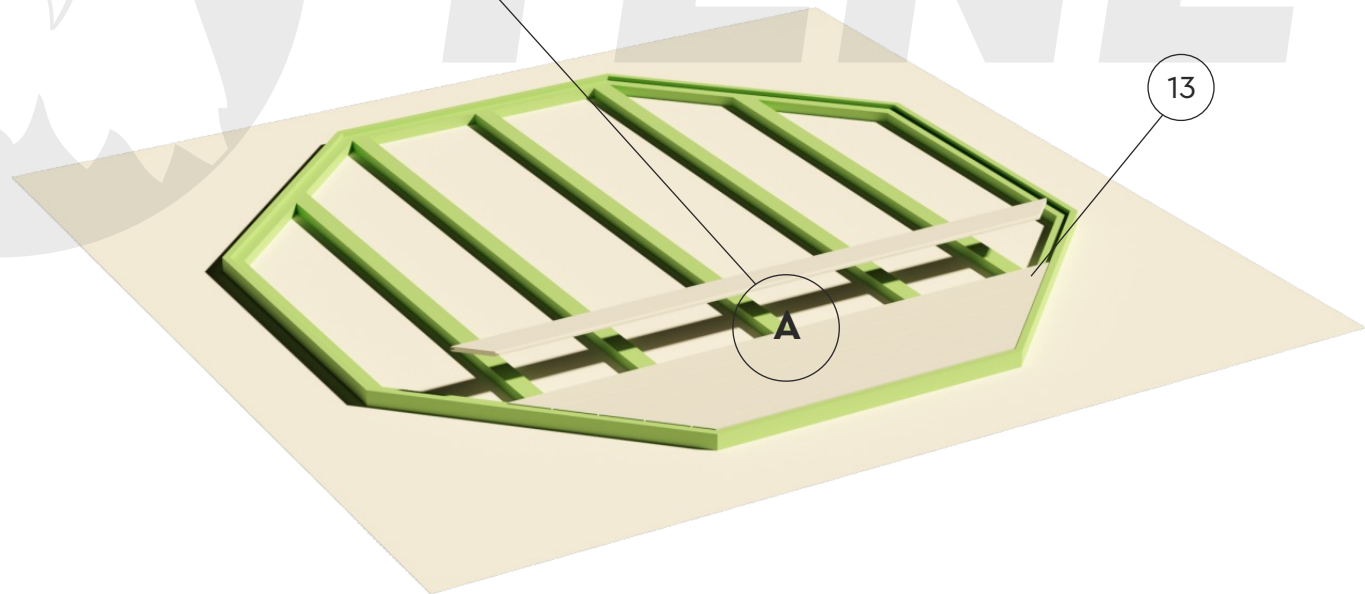

4x50 mm



LOUISE 4F 40

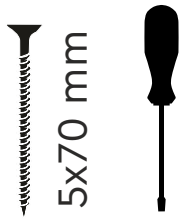
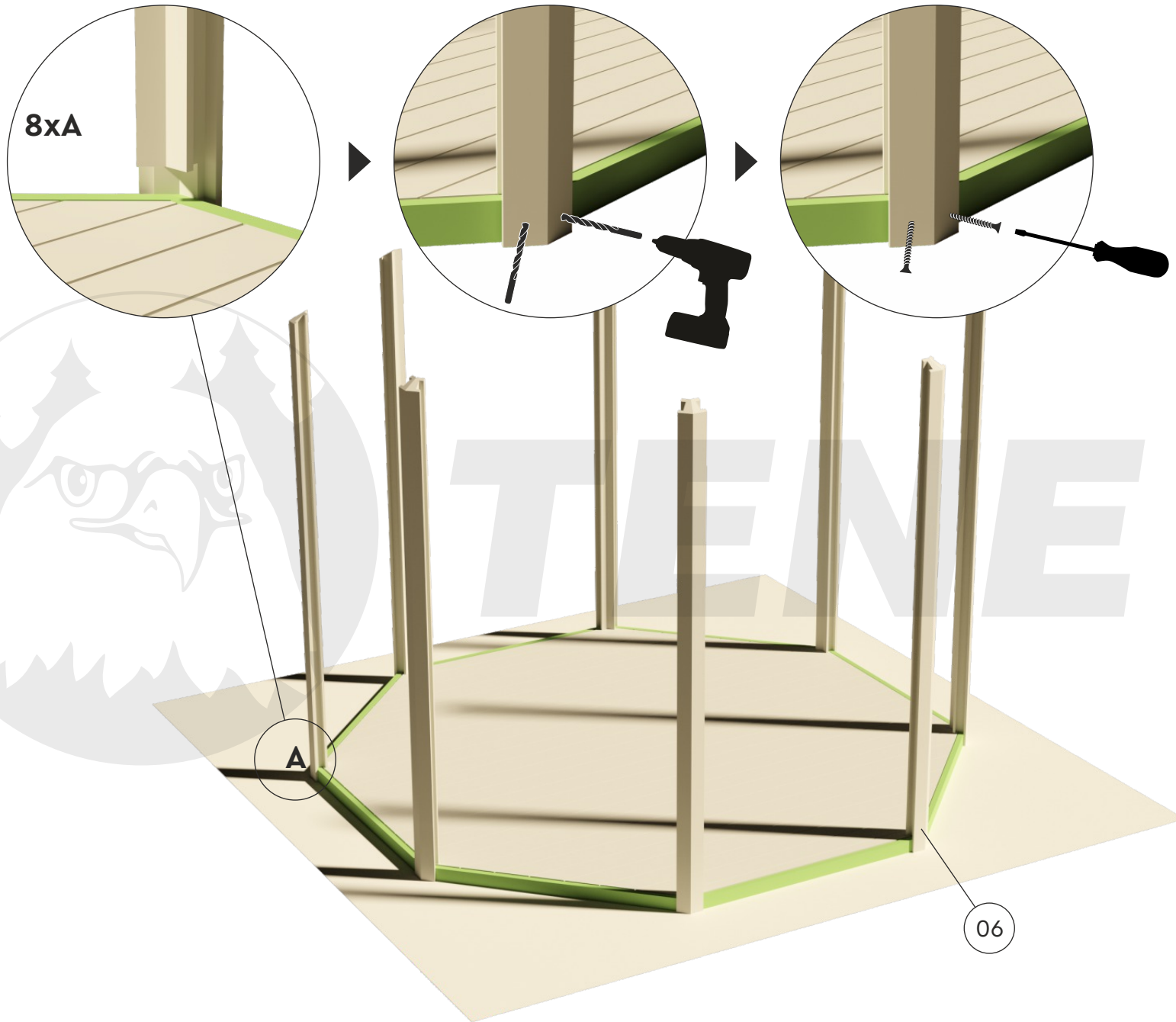

LOUISE 4F 40

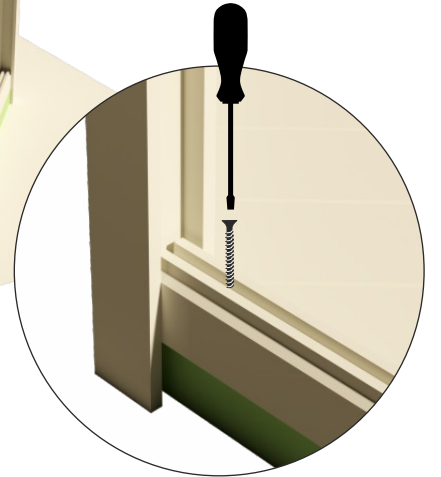
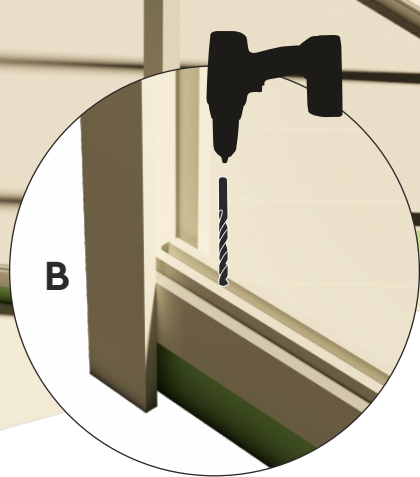
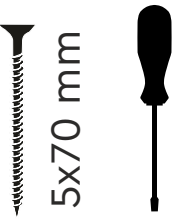
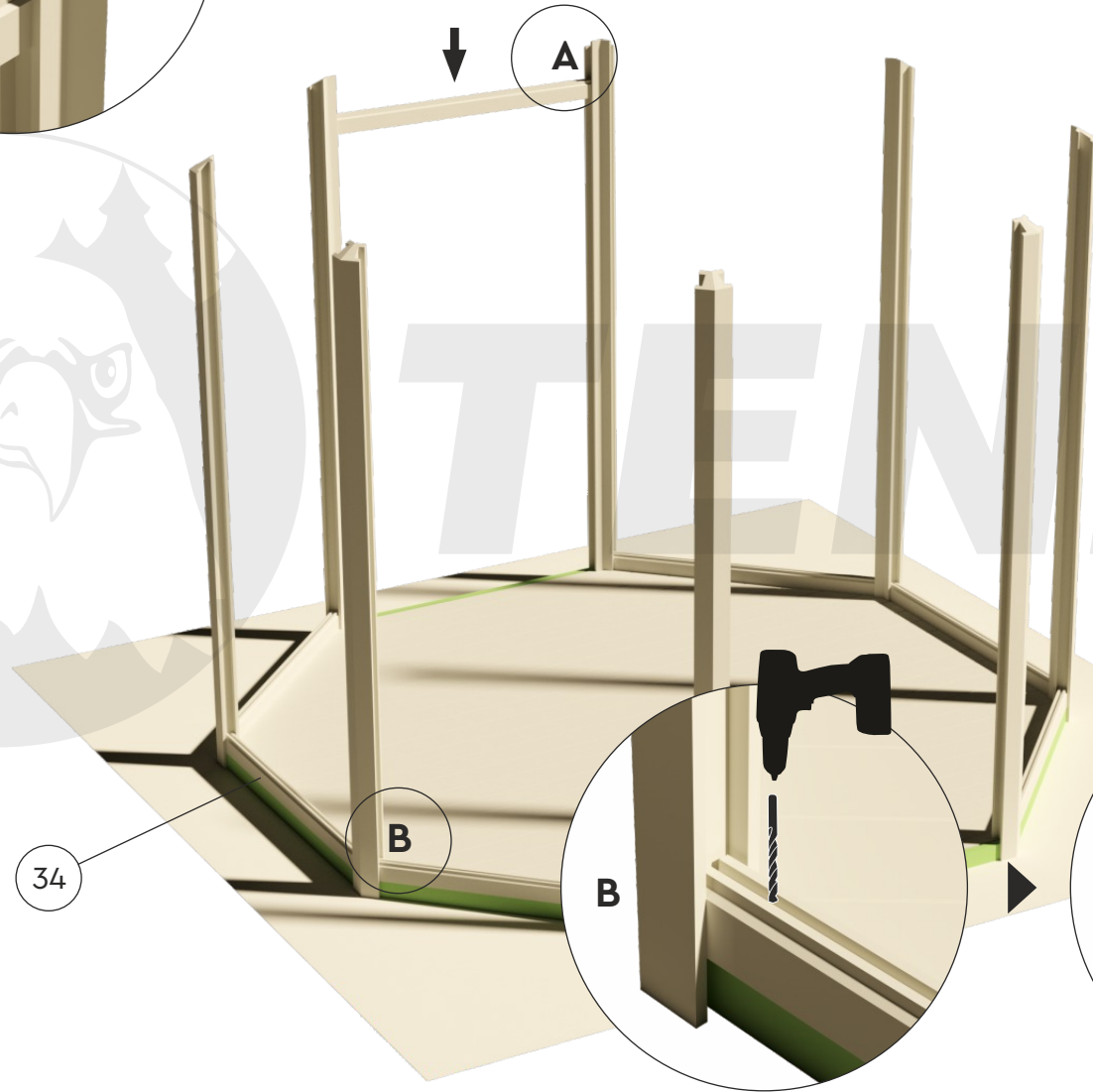
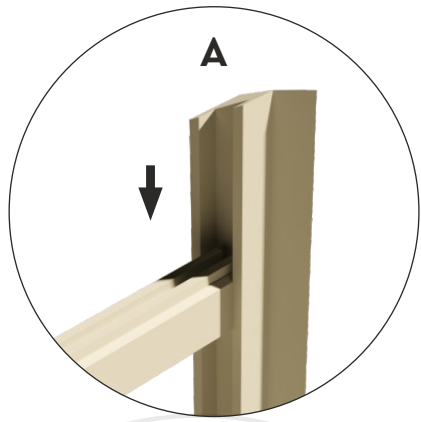

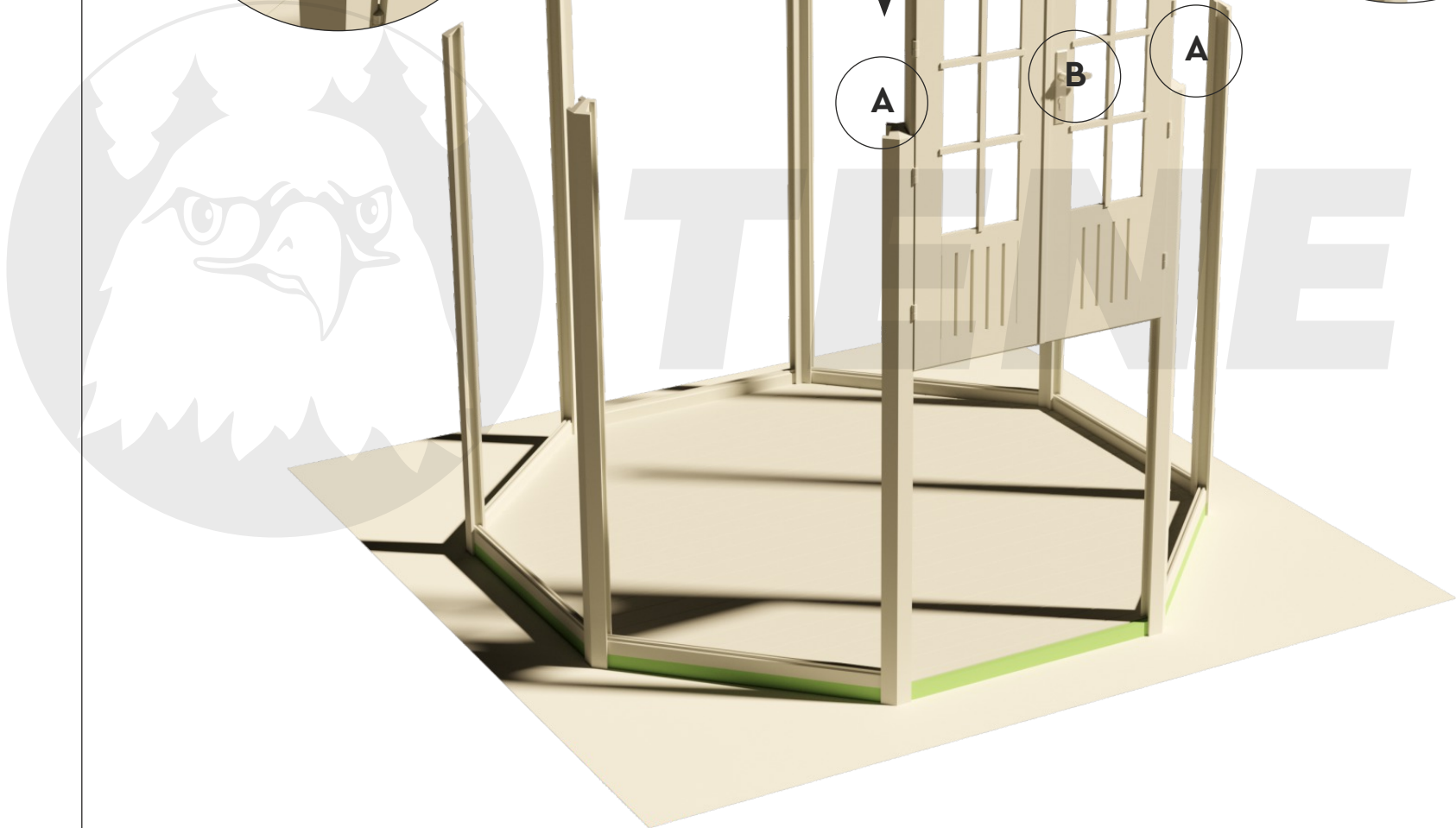
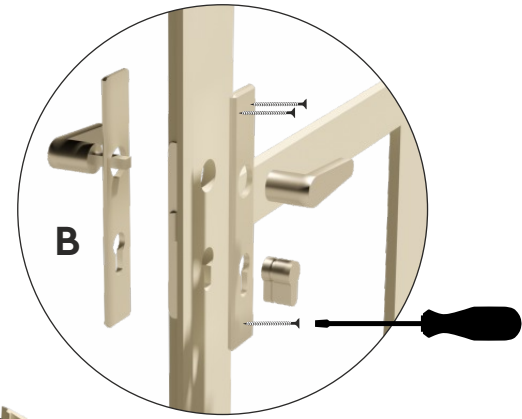
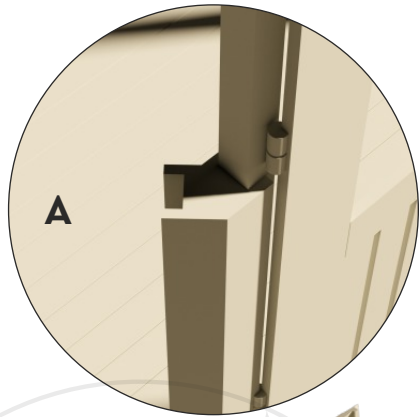

LOUISE 4F 40

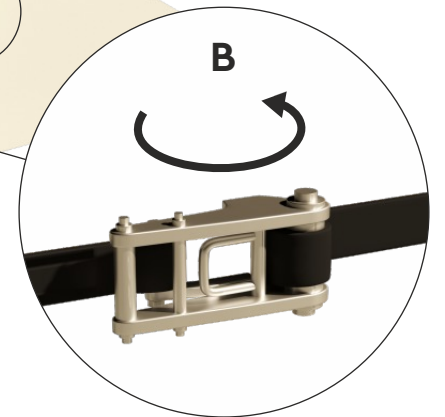
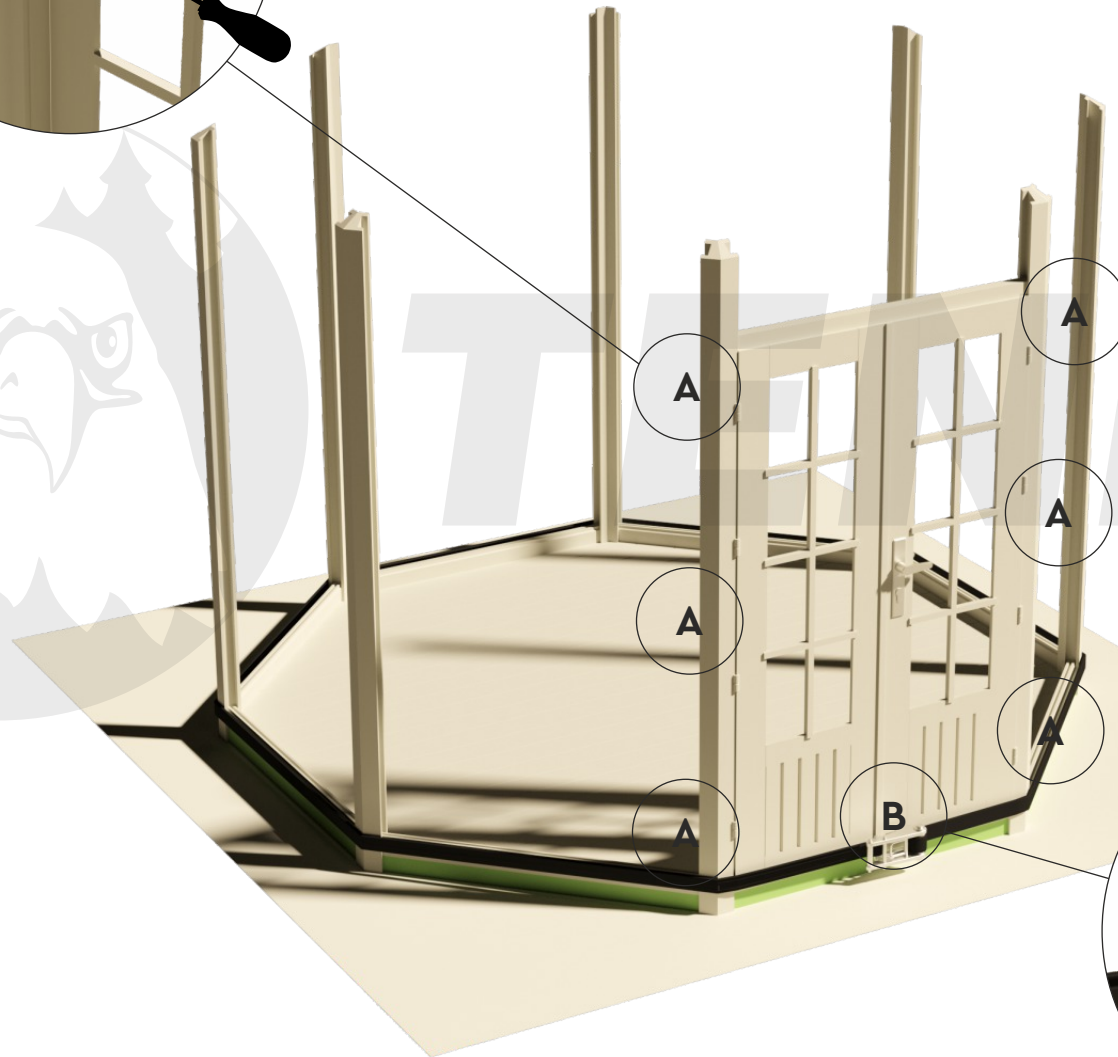
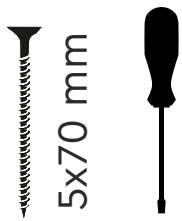
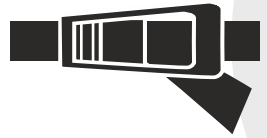
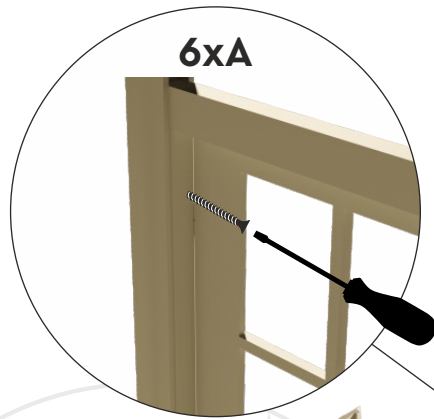

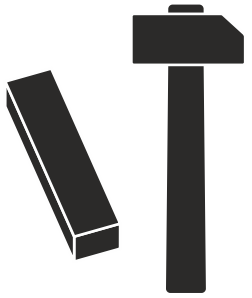
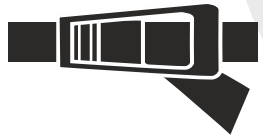
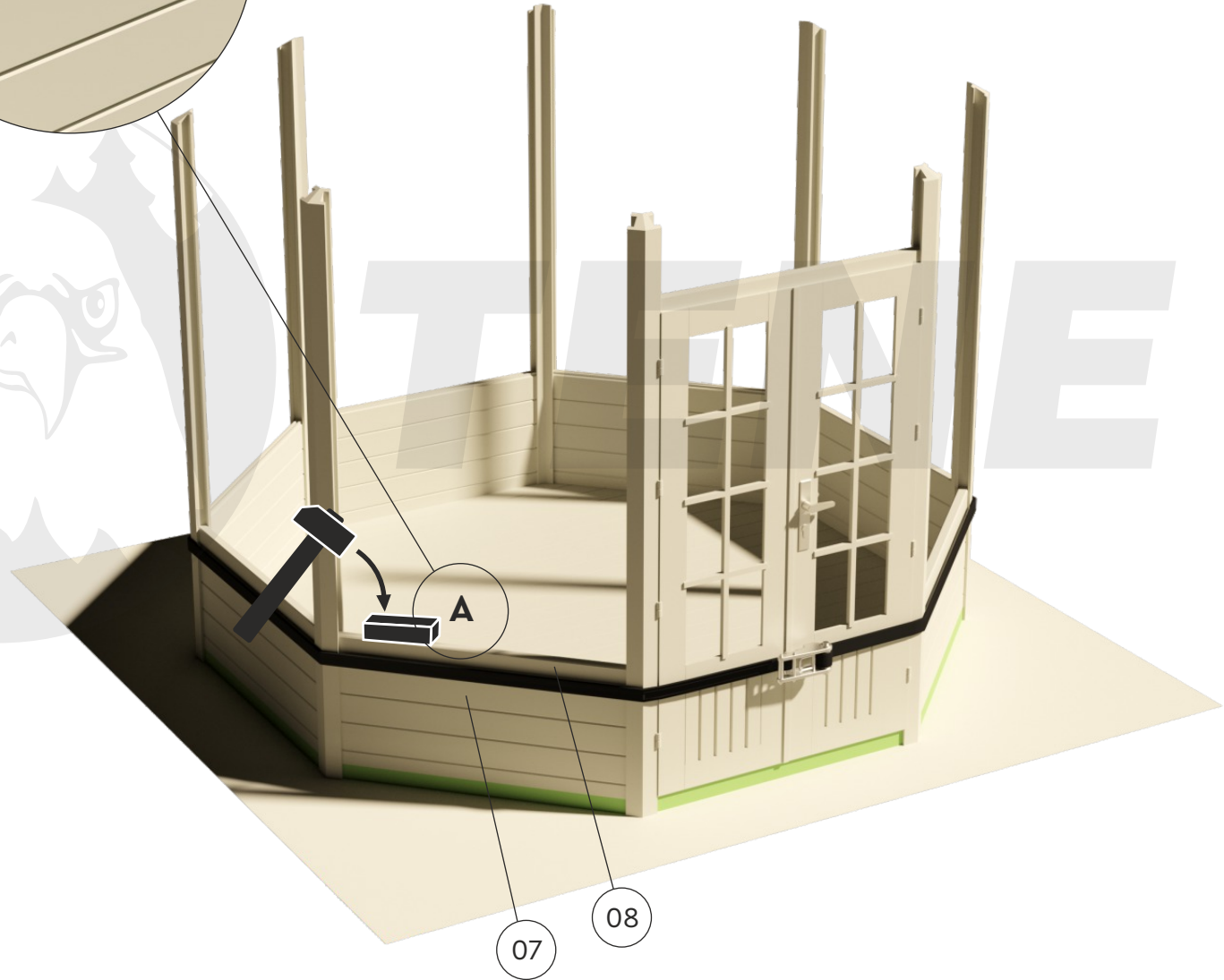
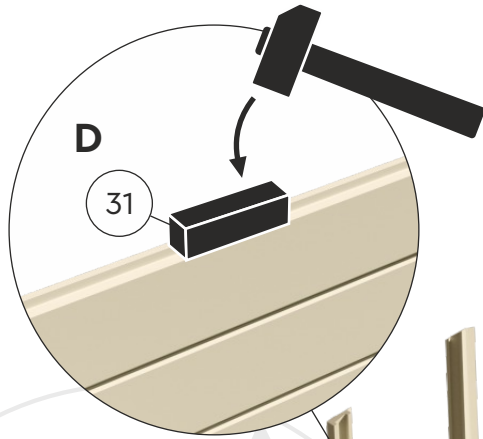

LOUISE 4F 40

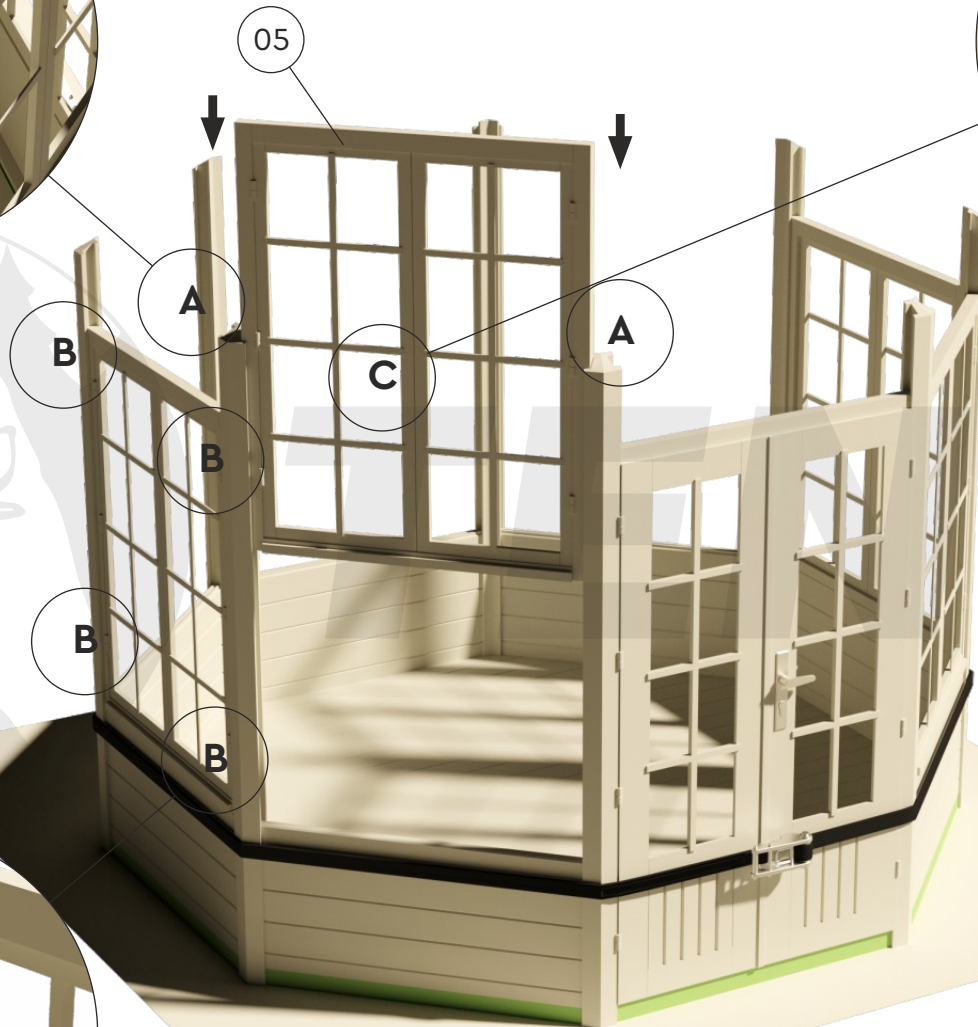
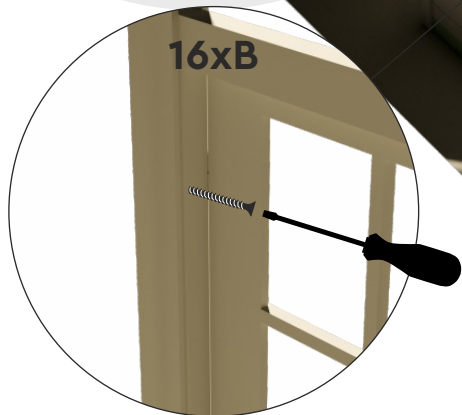
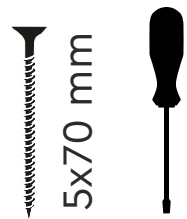
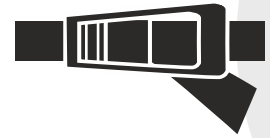
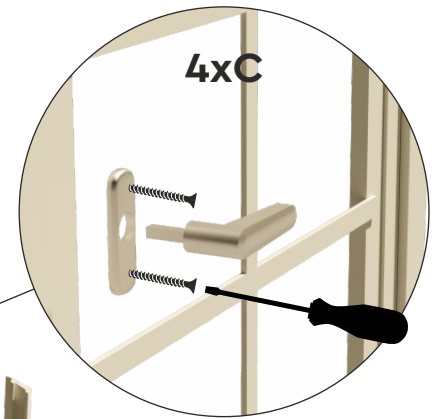
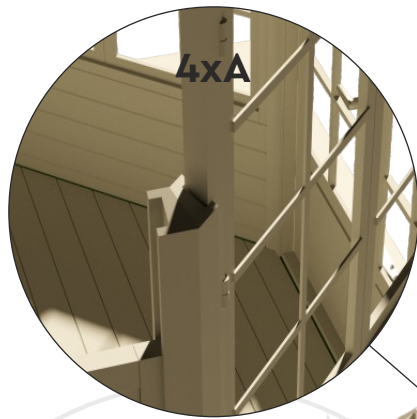

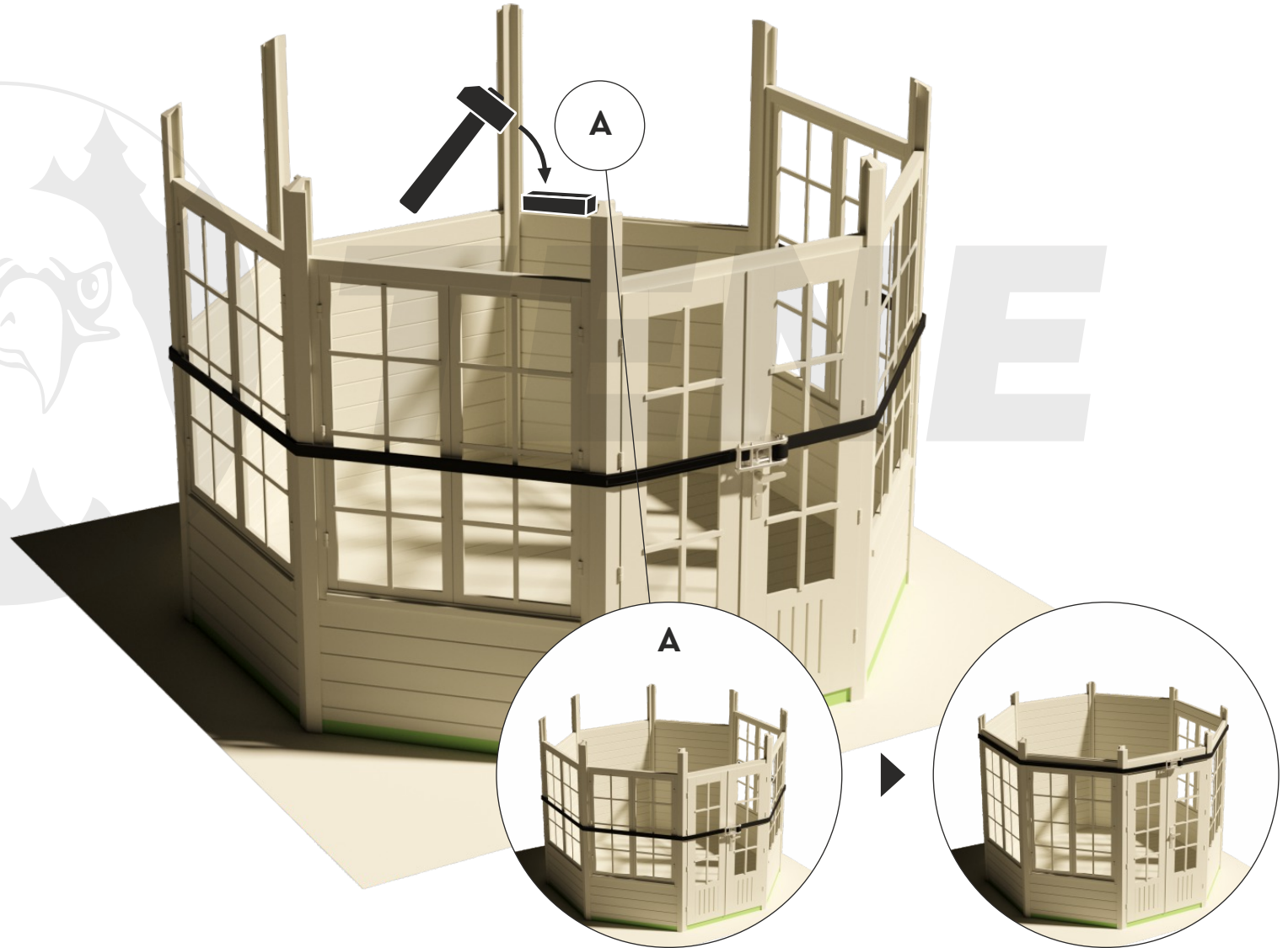
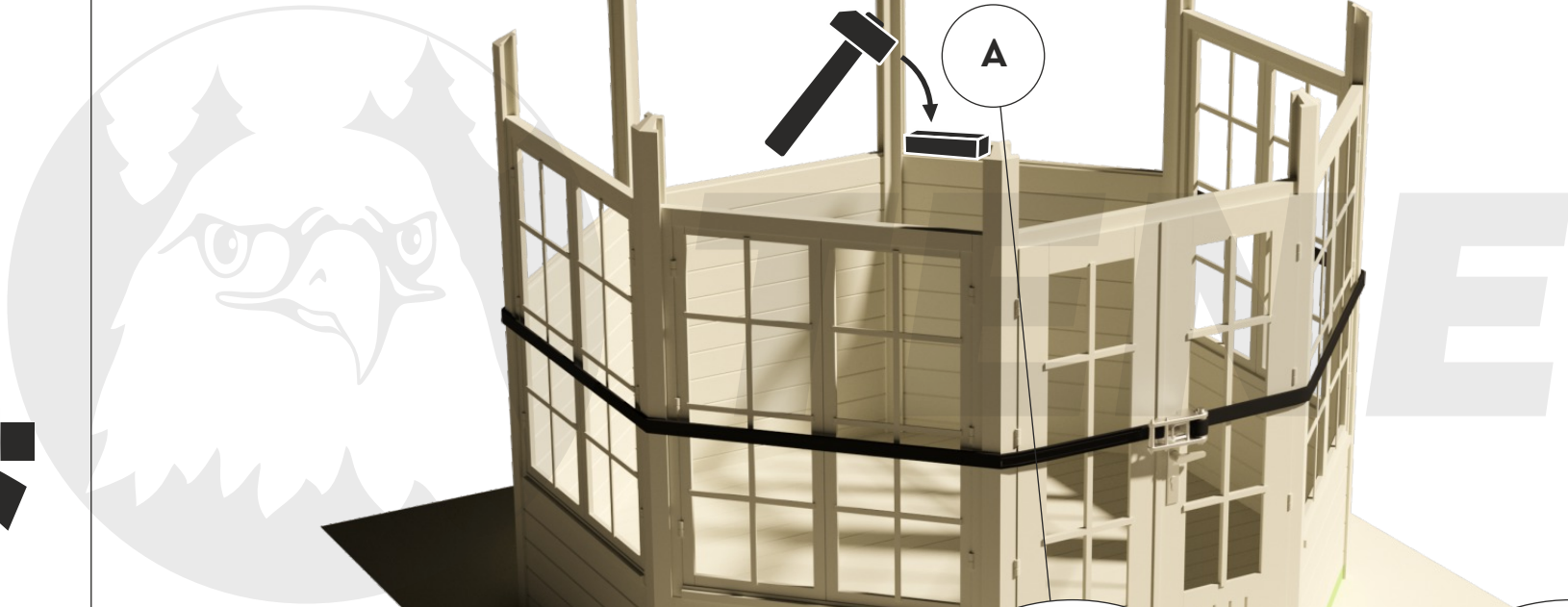
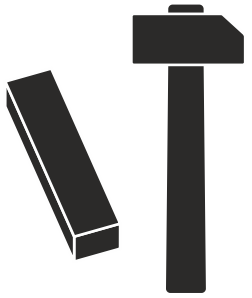
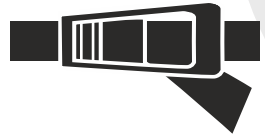

LOUISE 4F 40

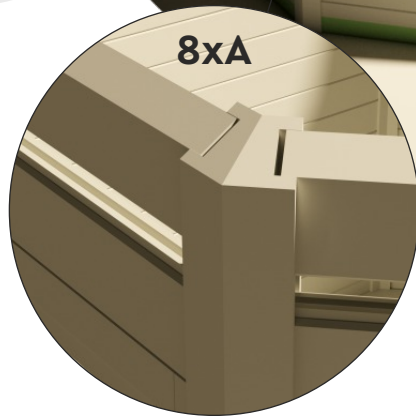
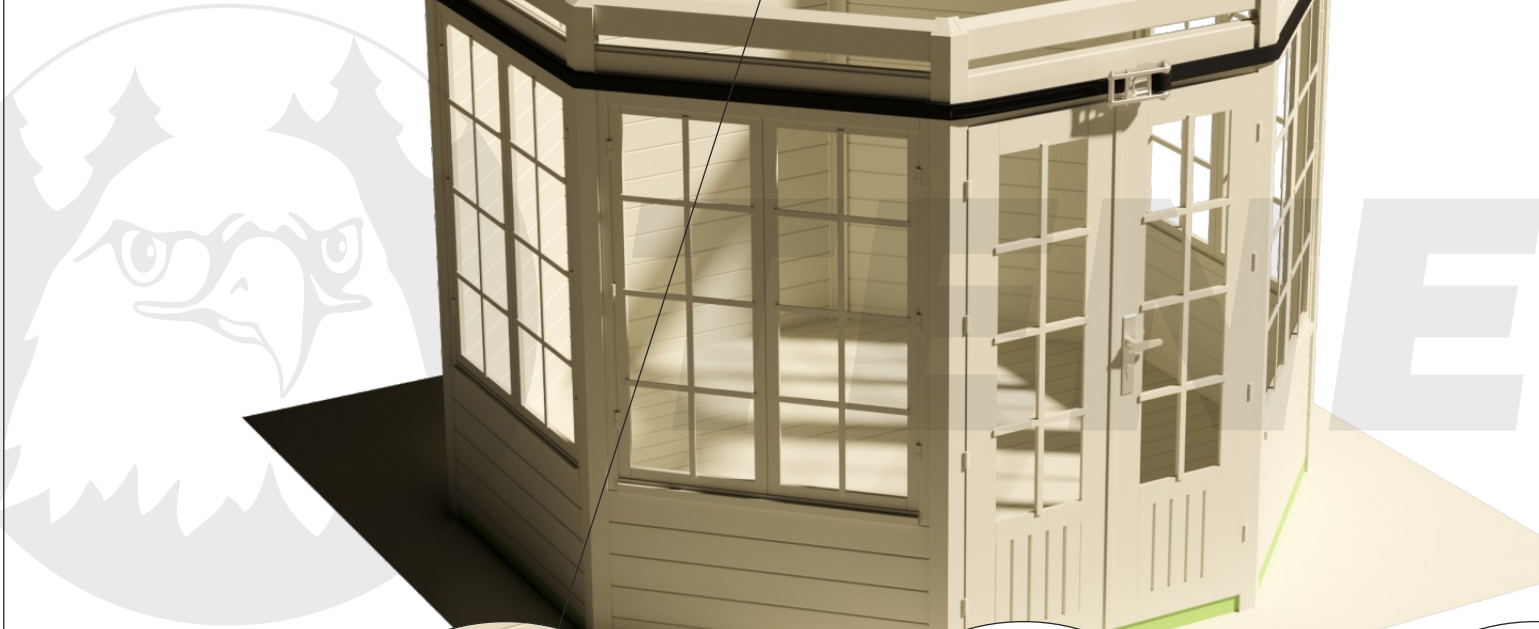
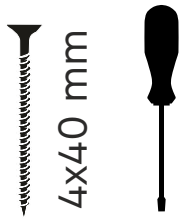
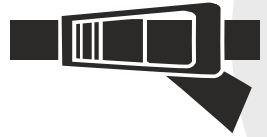

LOUISE 4F 40

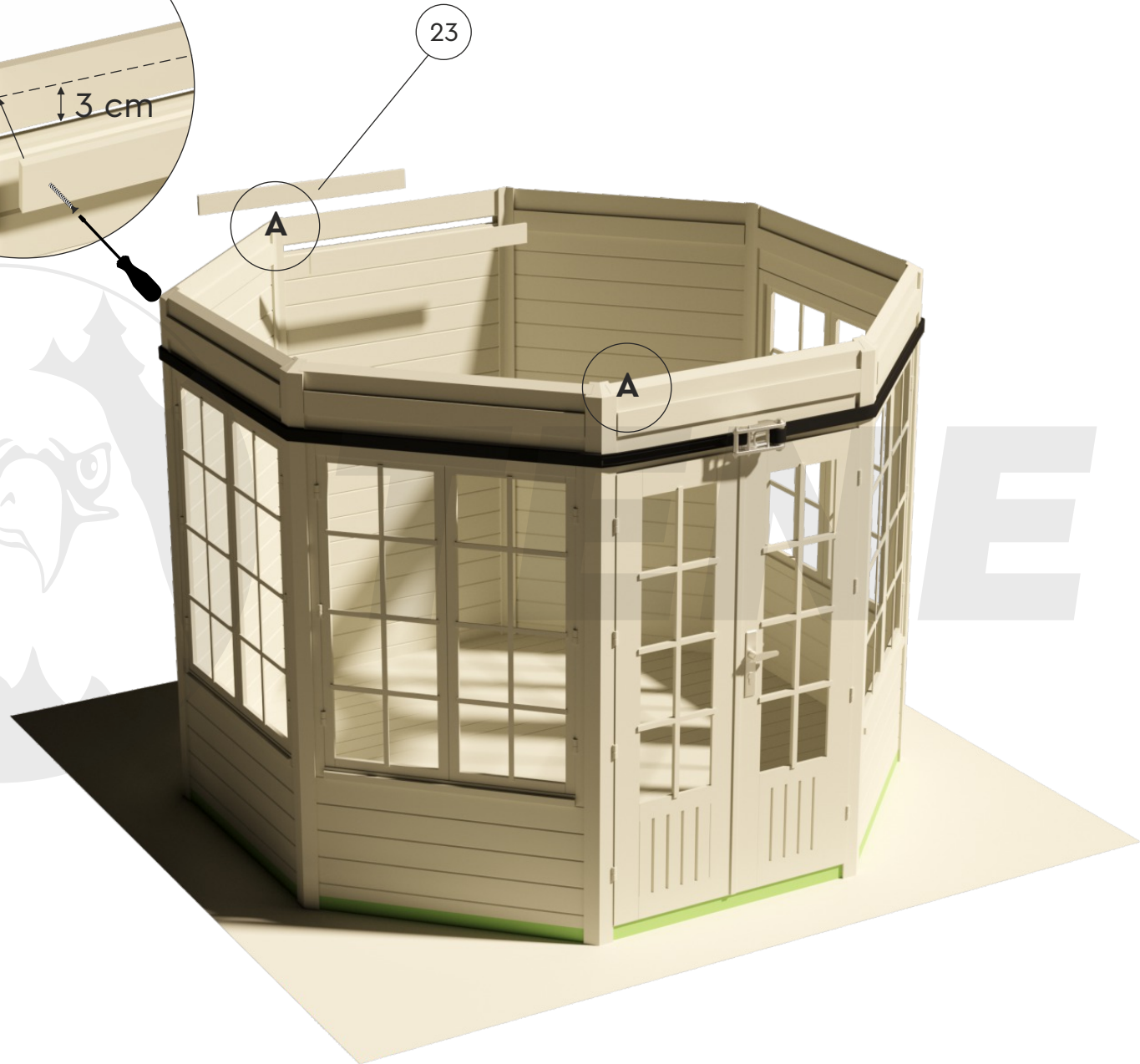
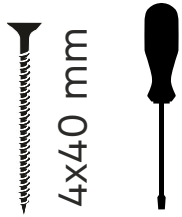
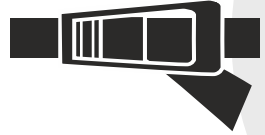
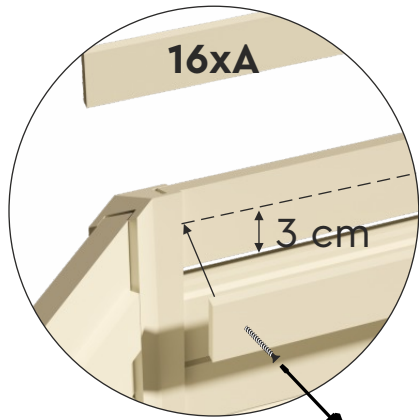

LOUISE 4F 40

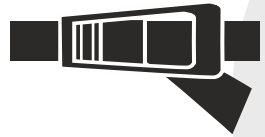

4x50 mm

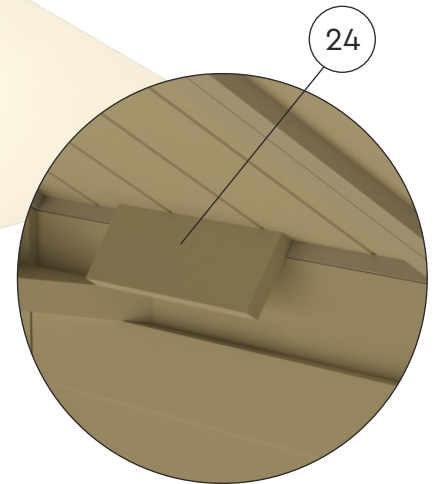
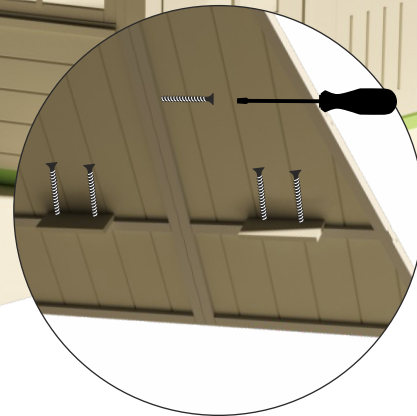
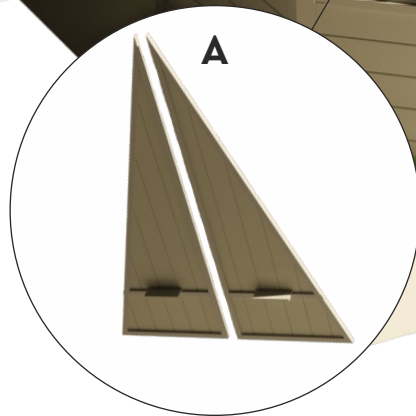
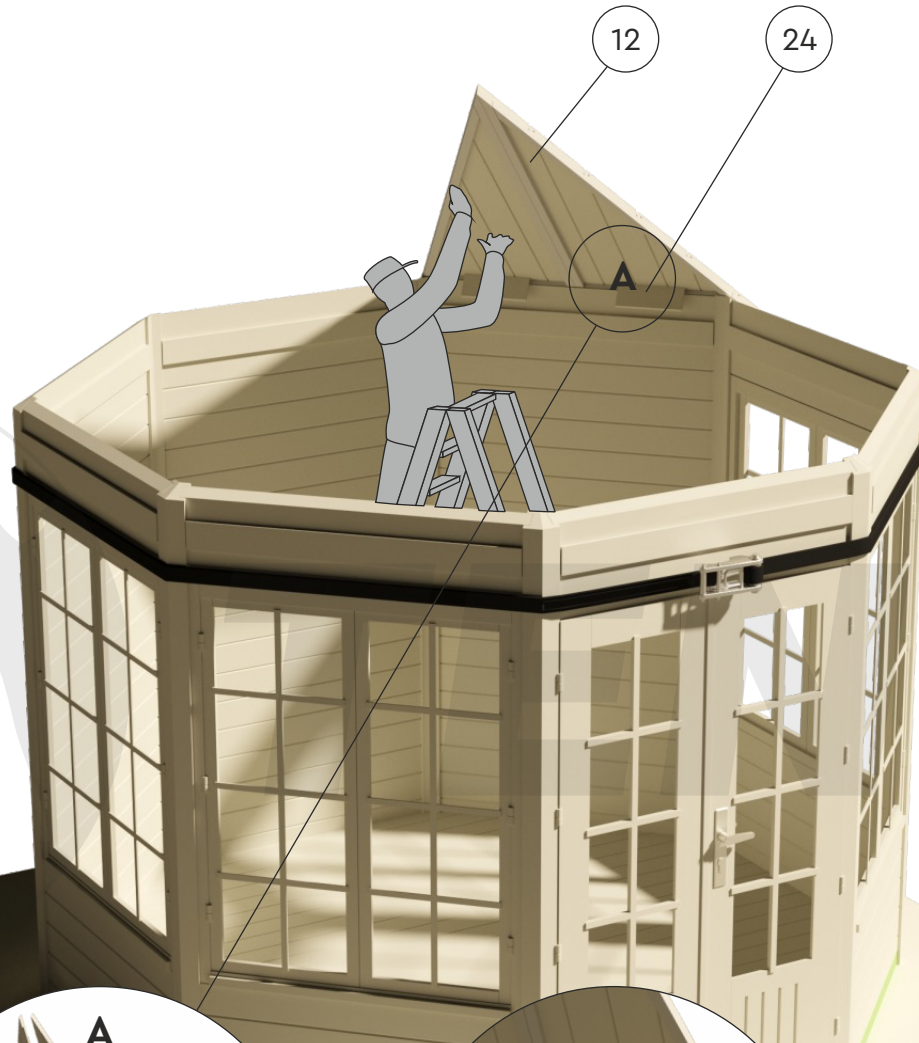

LOUISE 4F 40

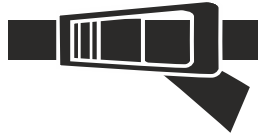

ø 4 mm



ø 5 mm



5x70 mm

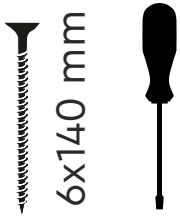

6x140 mm

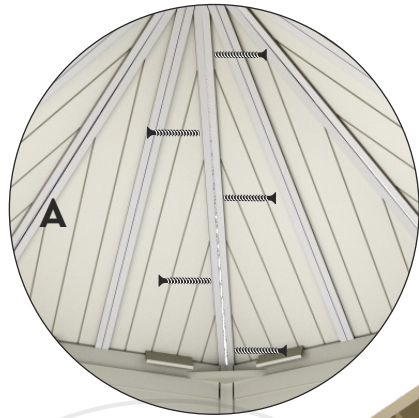

A

A

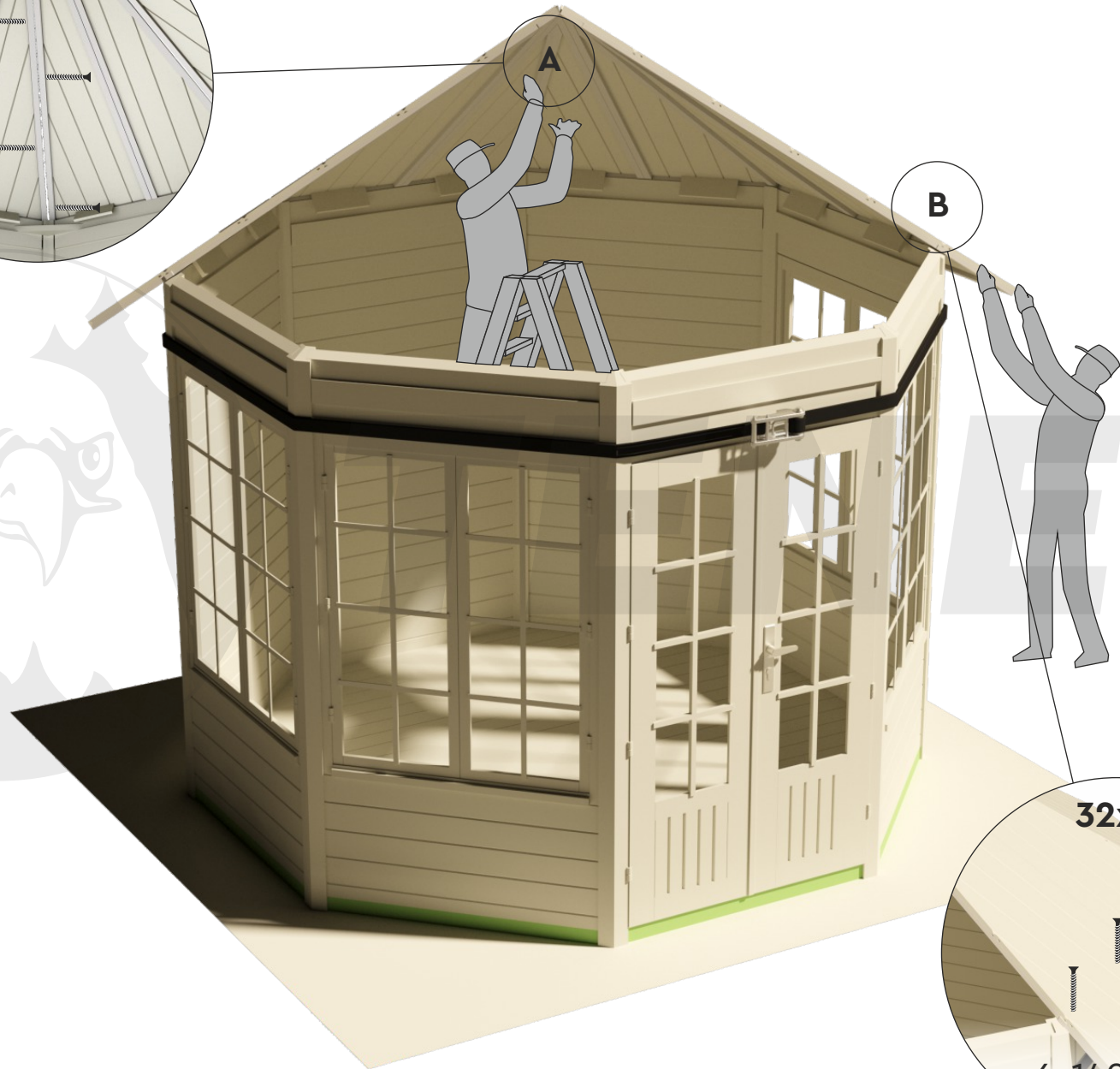

B

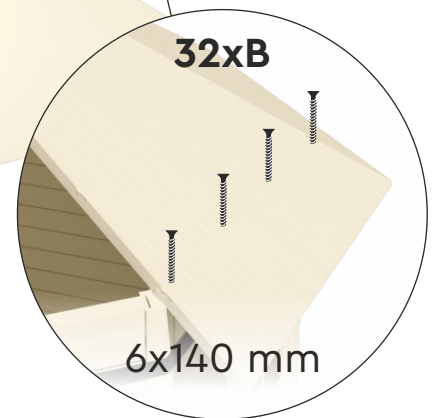

32xB

6x140 mm

LOUISE 4F 40

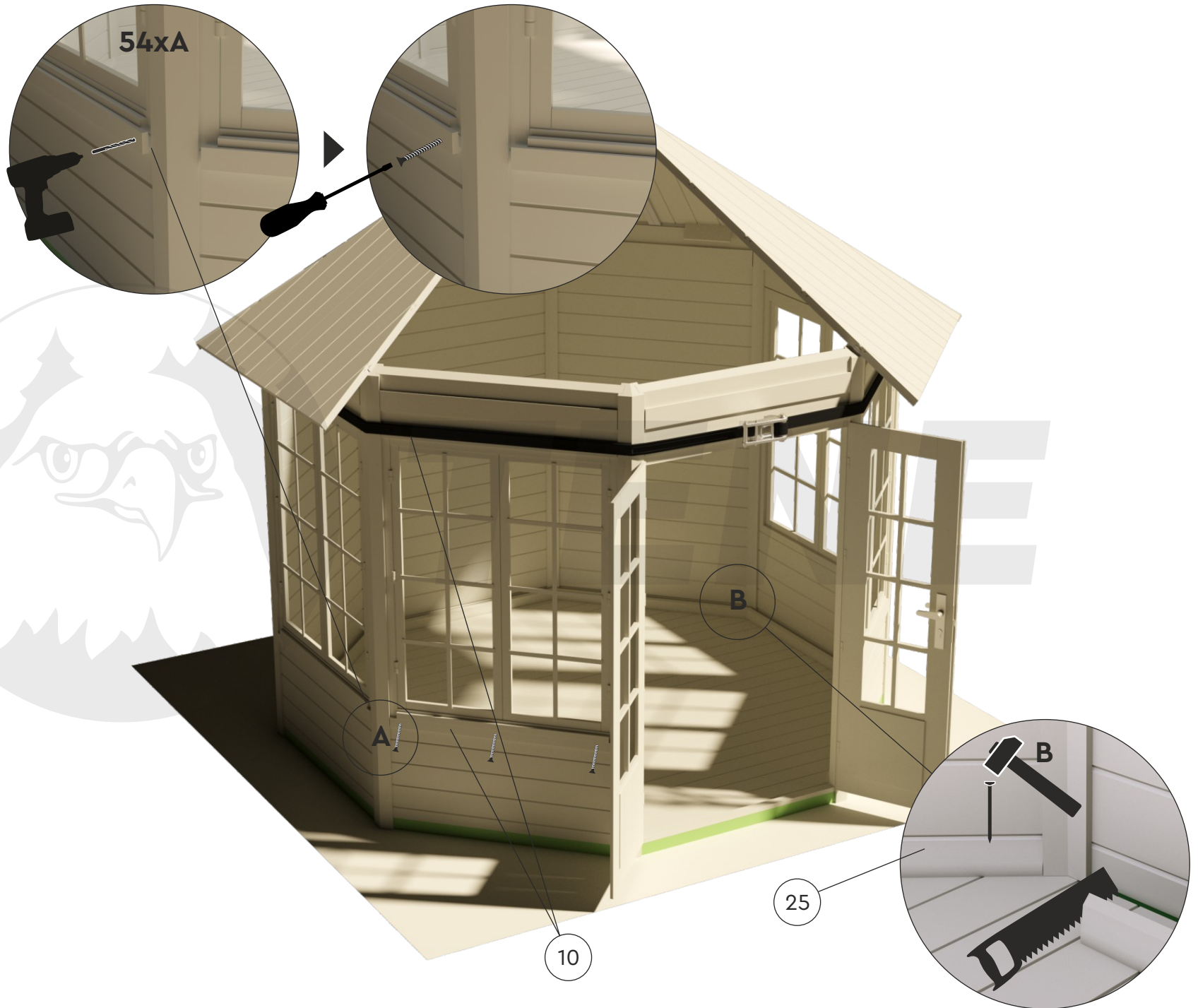
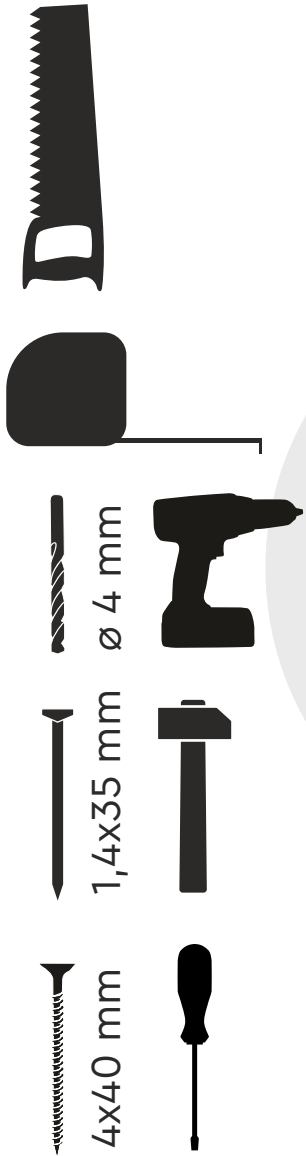

LOUISE 4F 40

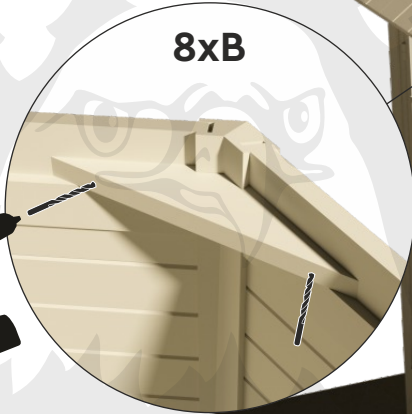
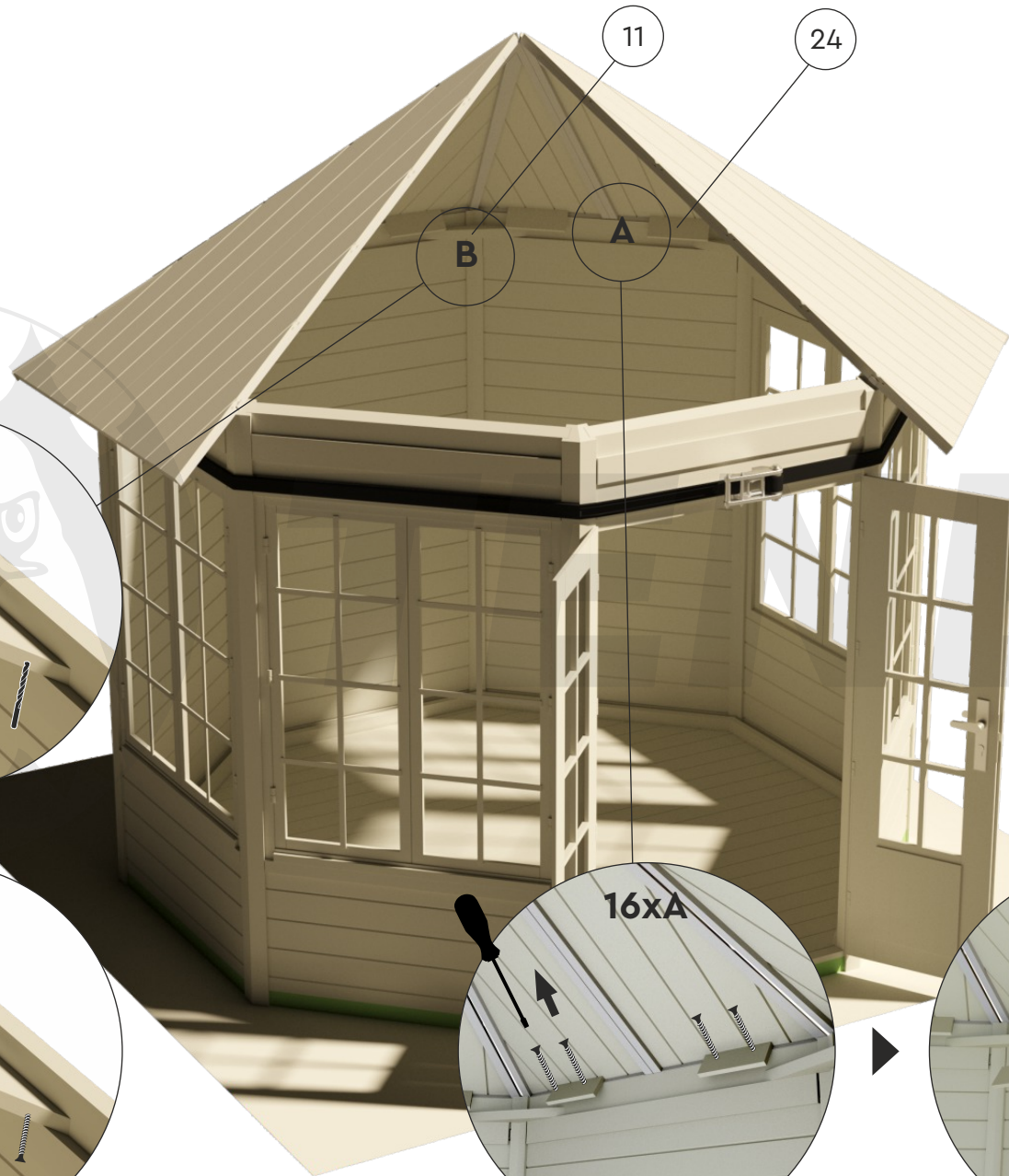

8xB



$\varnothing 4 \text{ mm}$



5x70 mm

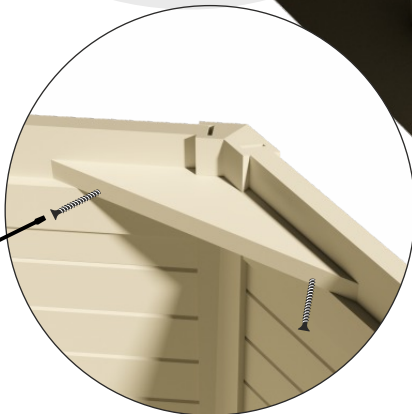

16xA

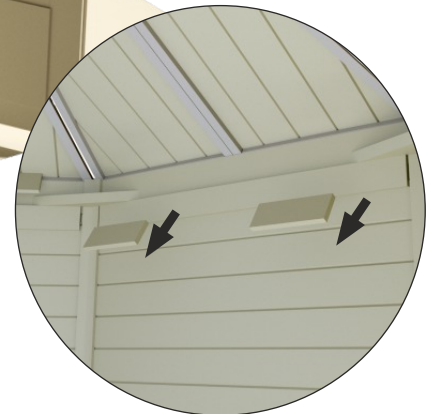

LOUISE 4F 40

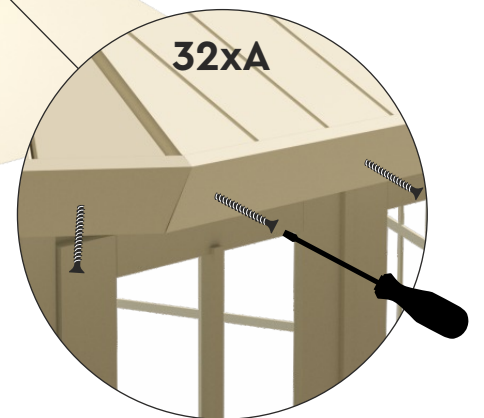
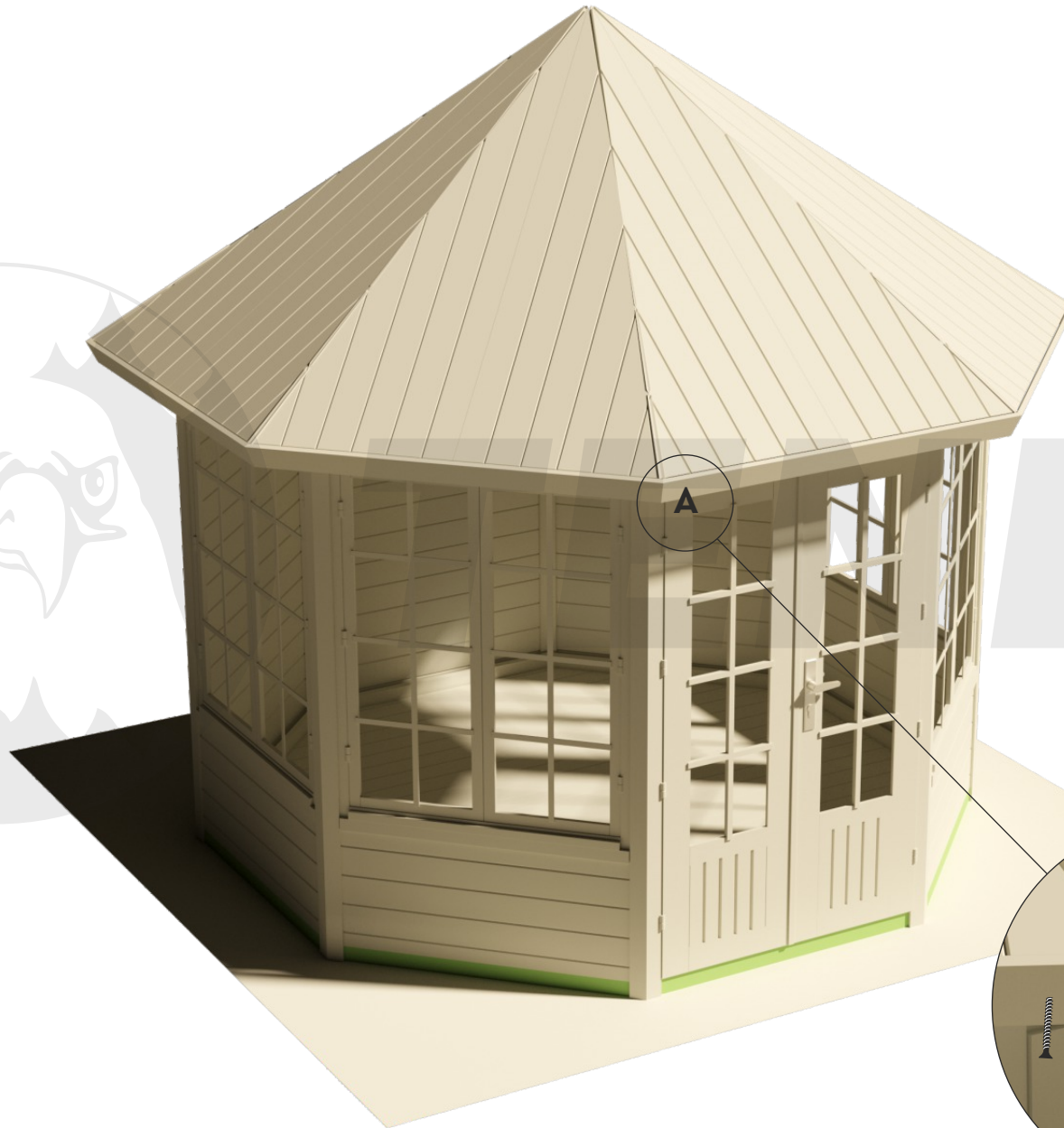
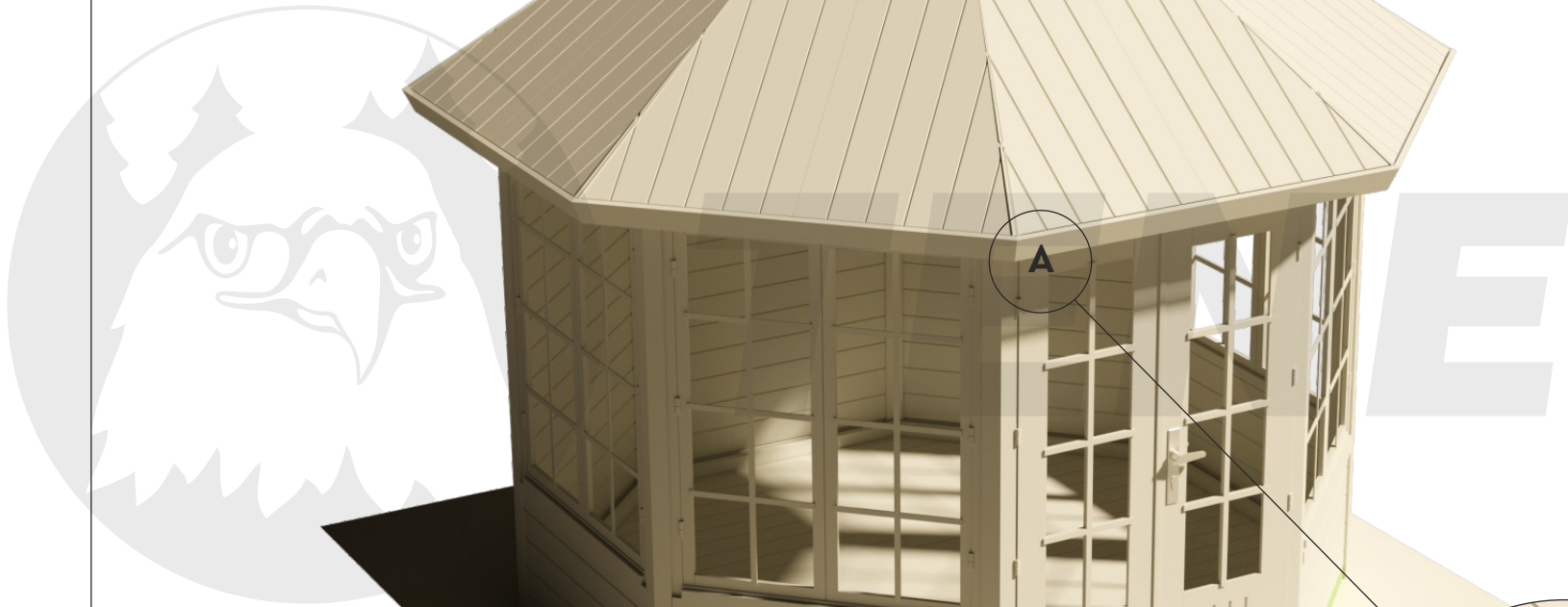

4x40 mm



LOUISE 4F 40

