

OKLAHOMA 40

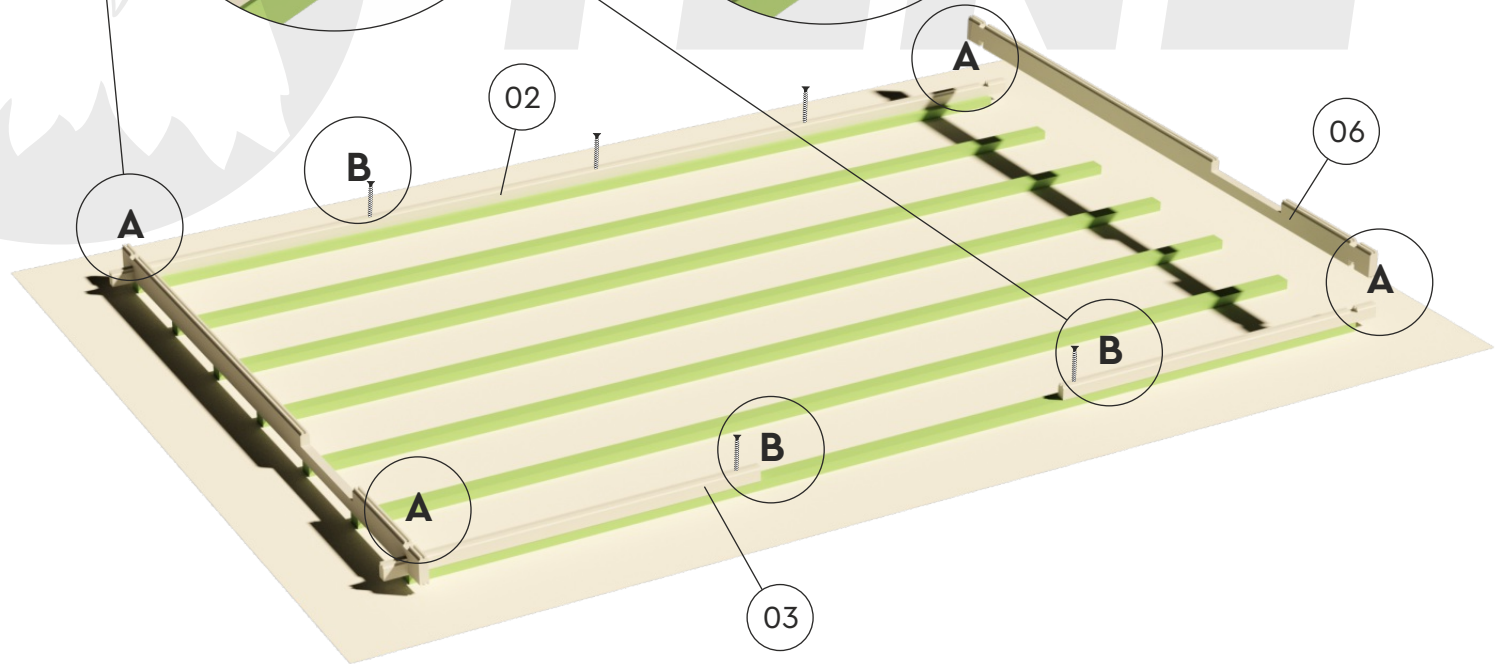

OKLAHOMA 40

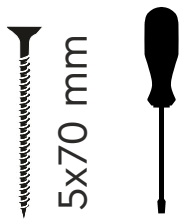

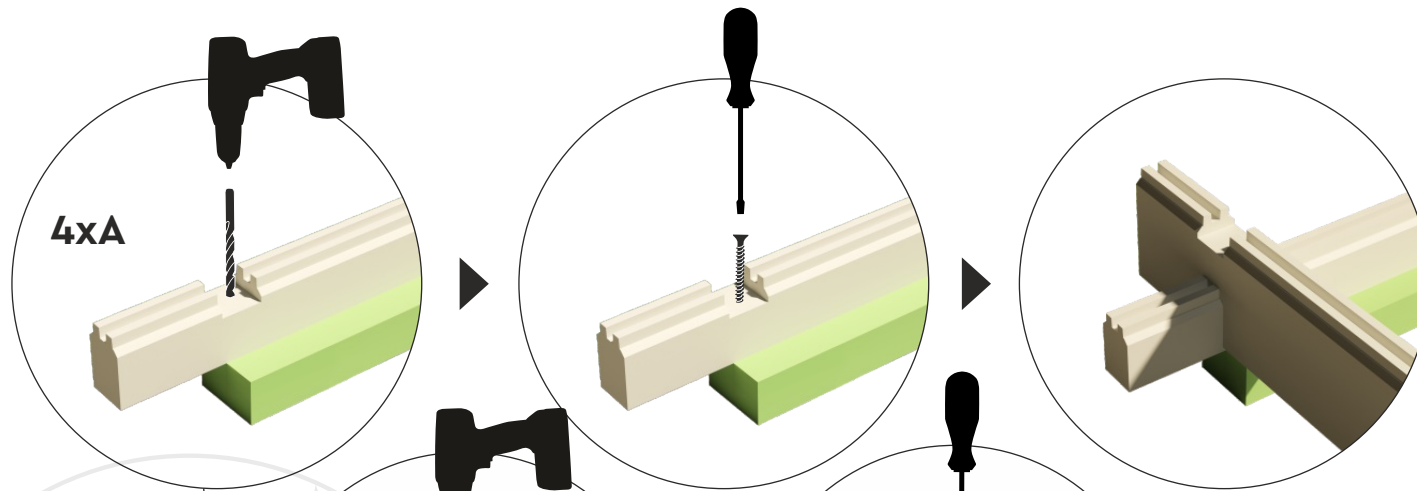
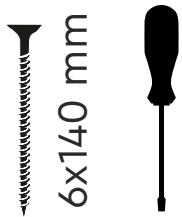
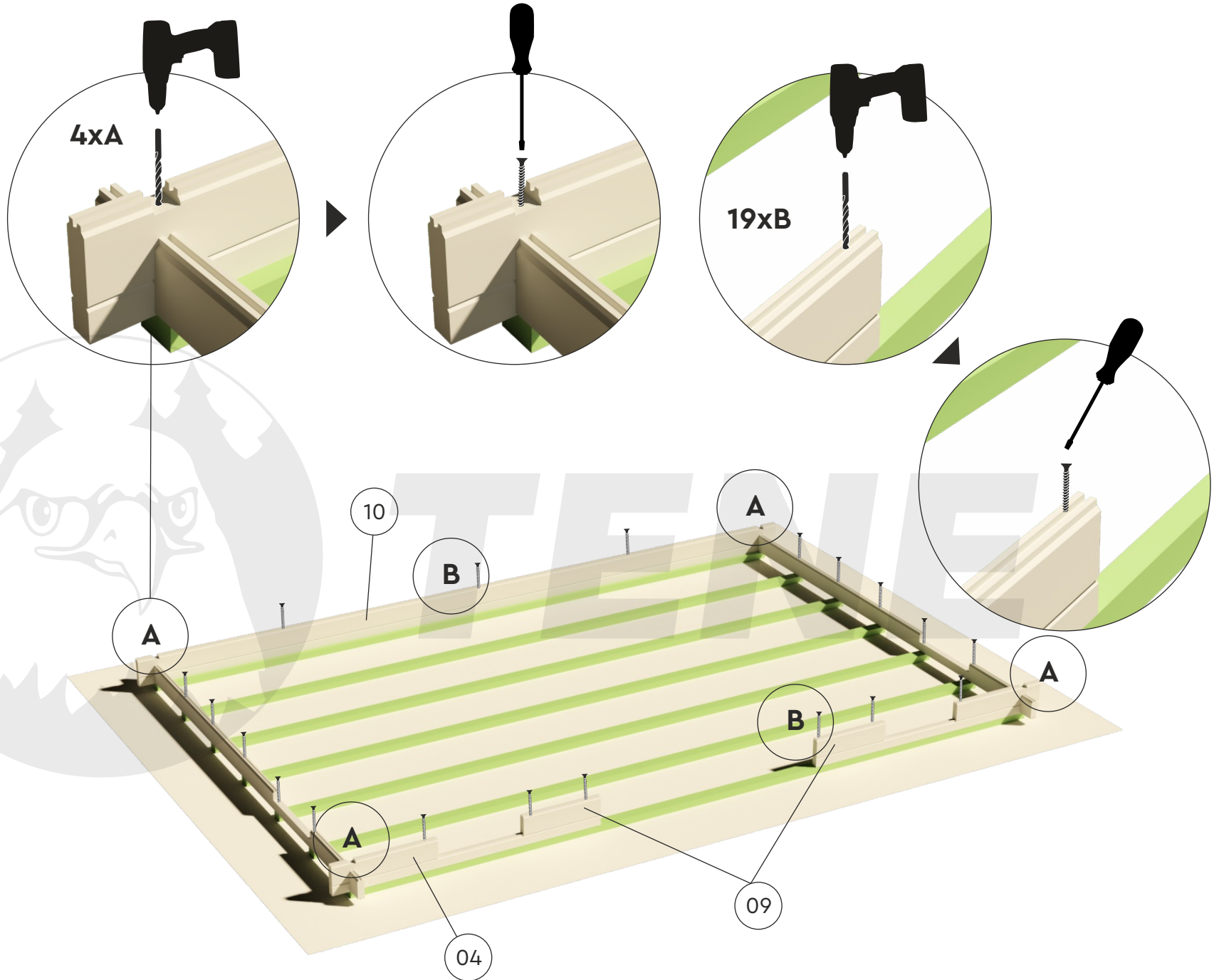
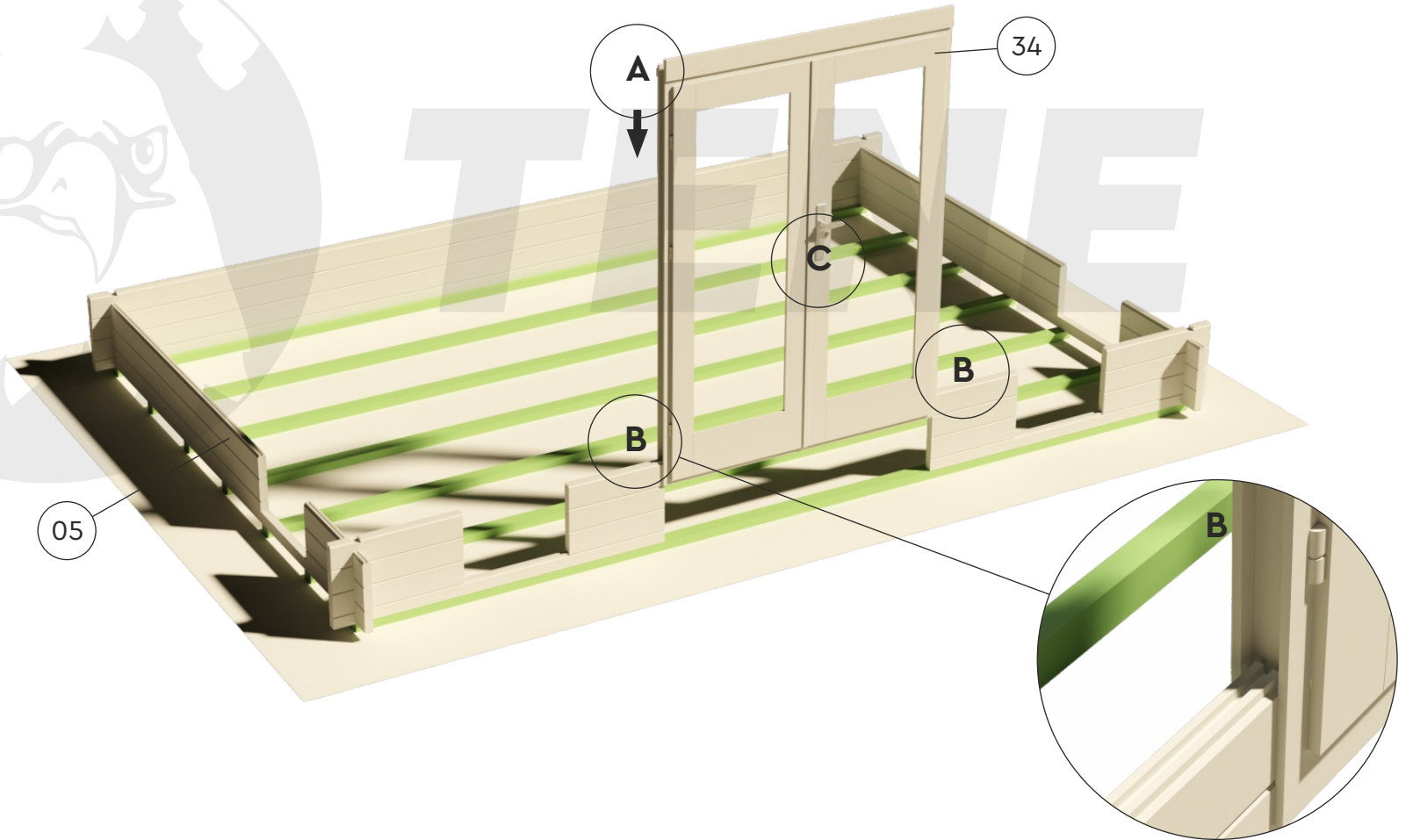
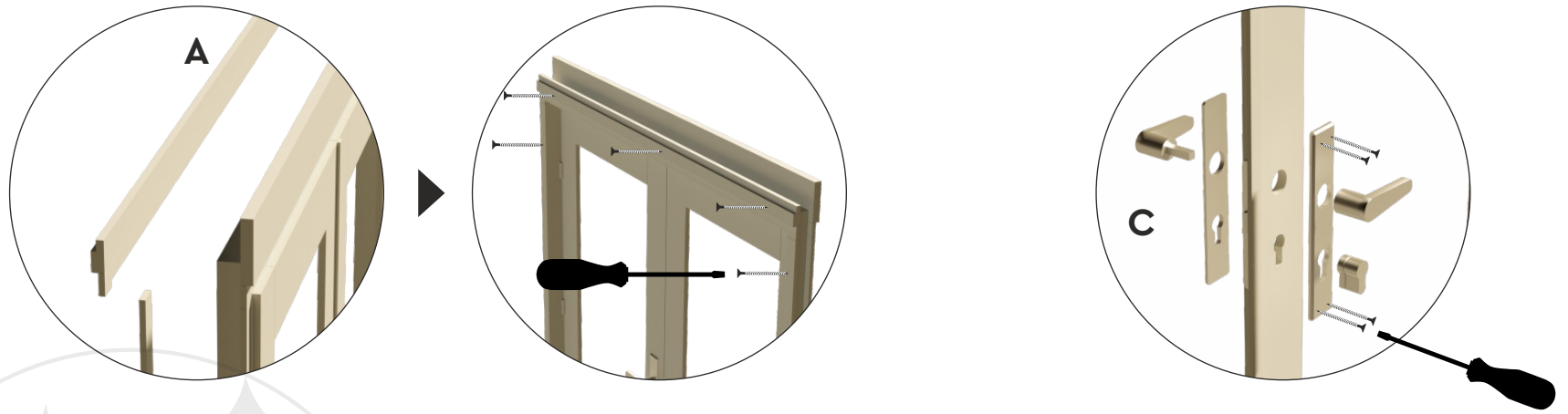

4x40 mm



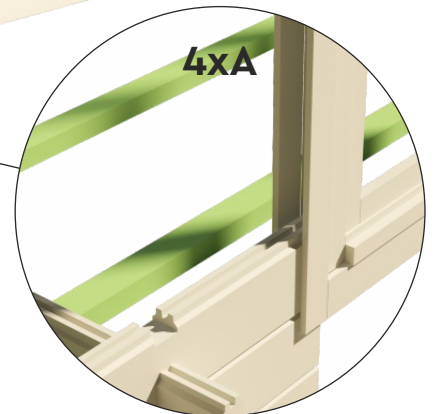
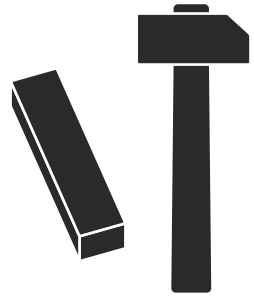
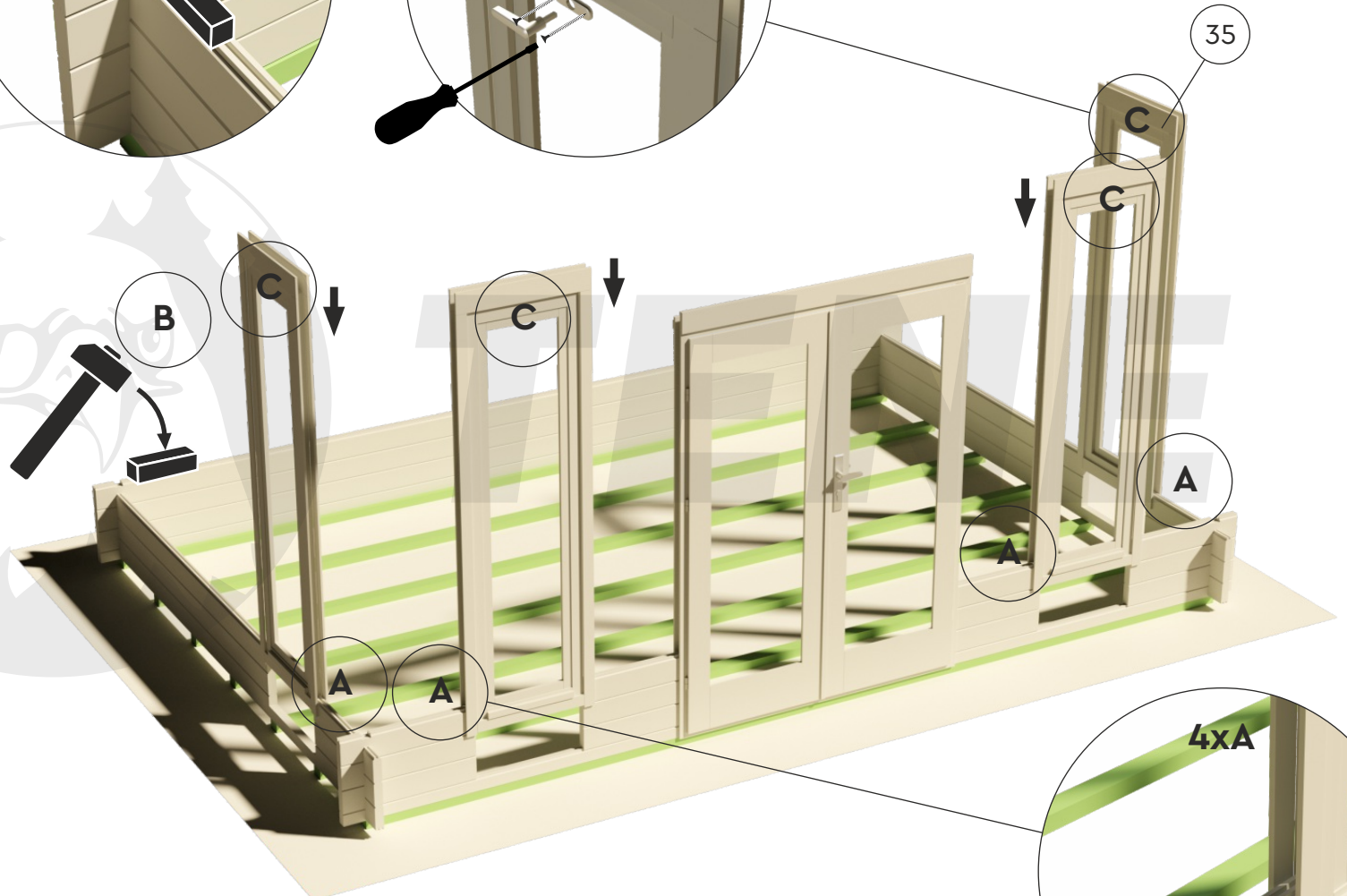
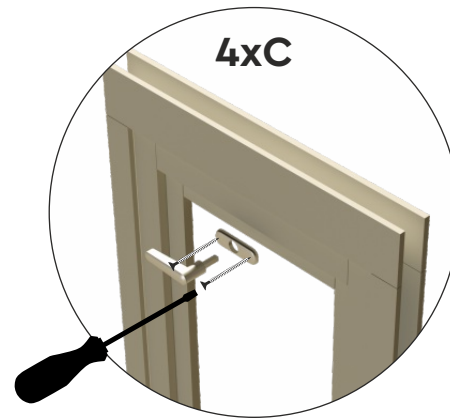
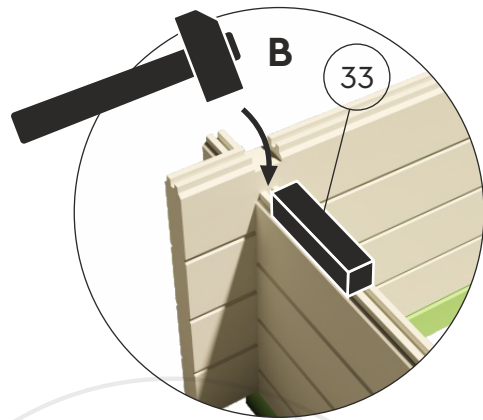

OKLAHOMA 40

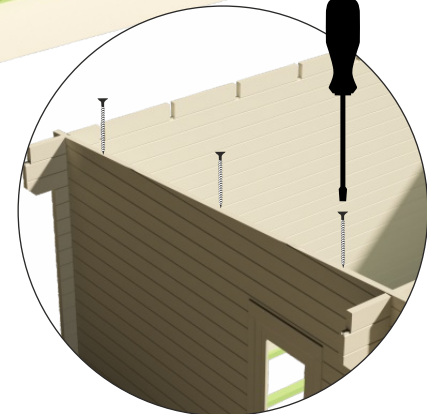
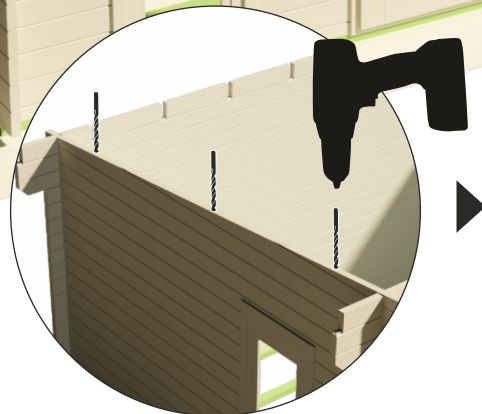
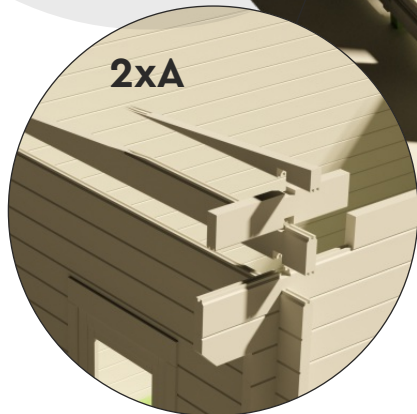
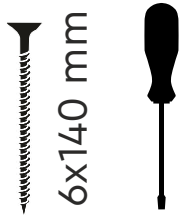
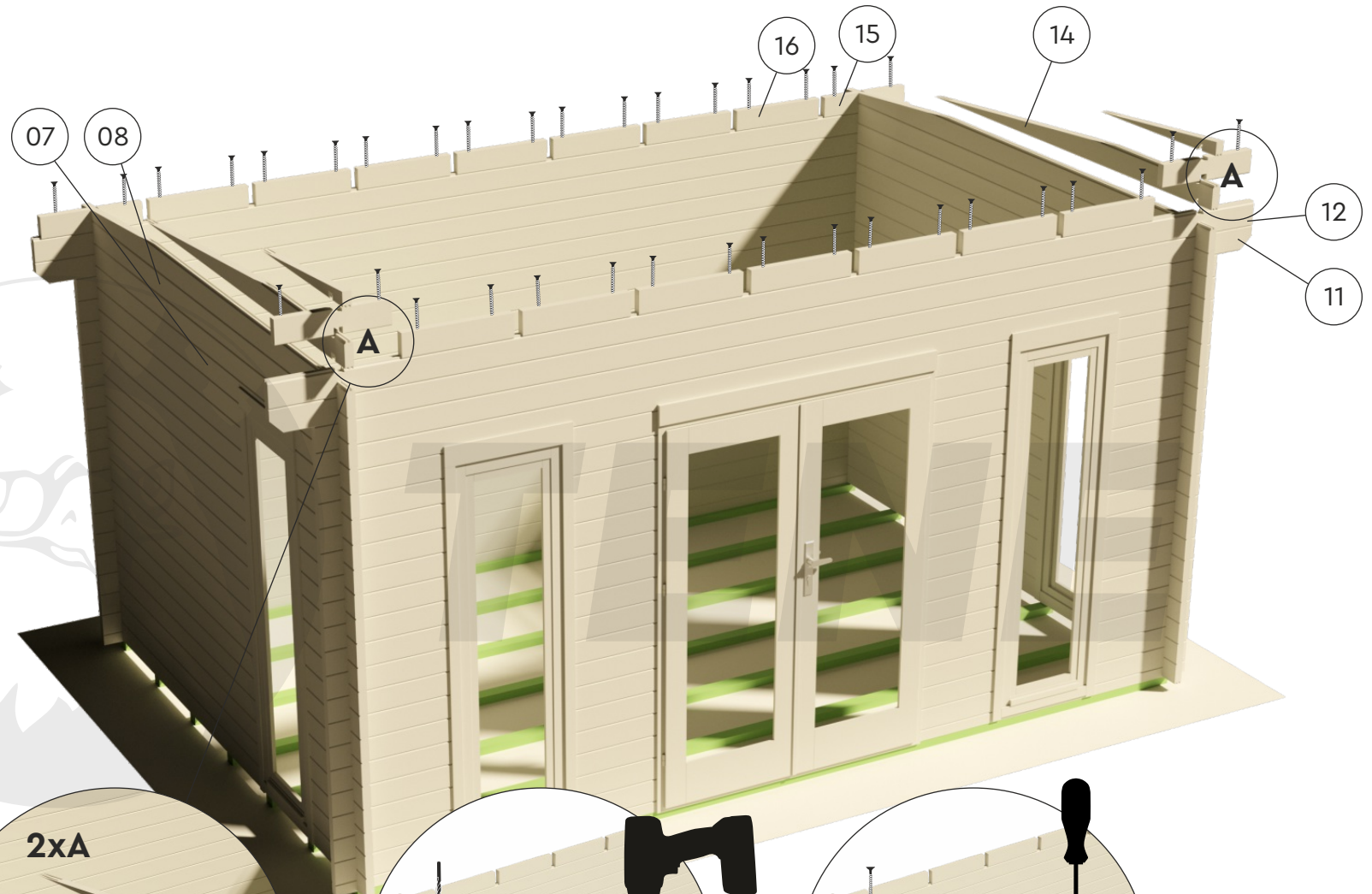

OKLAHOMA 40

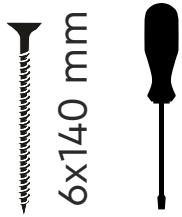
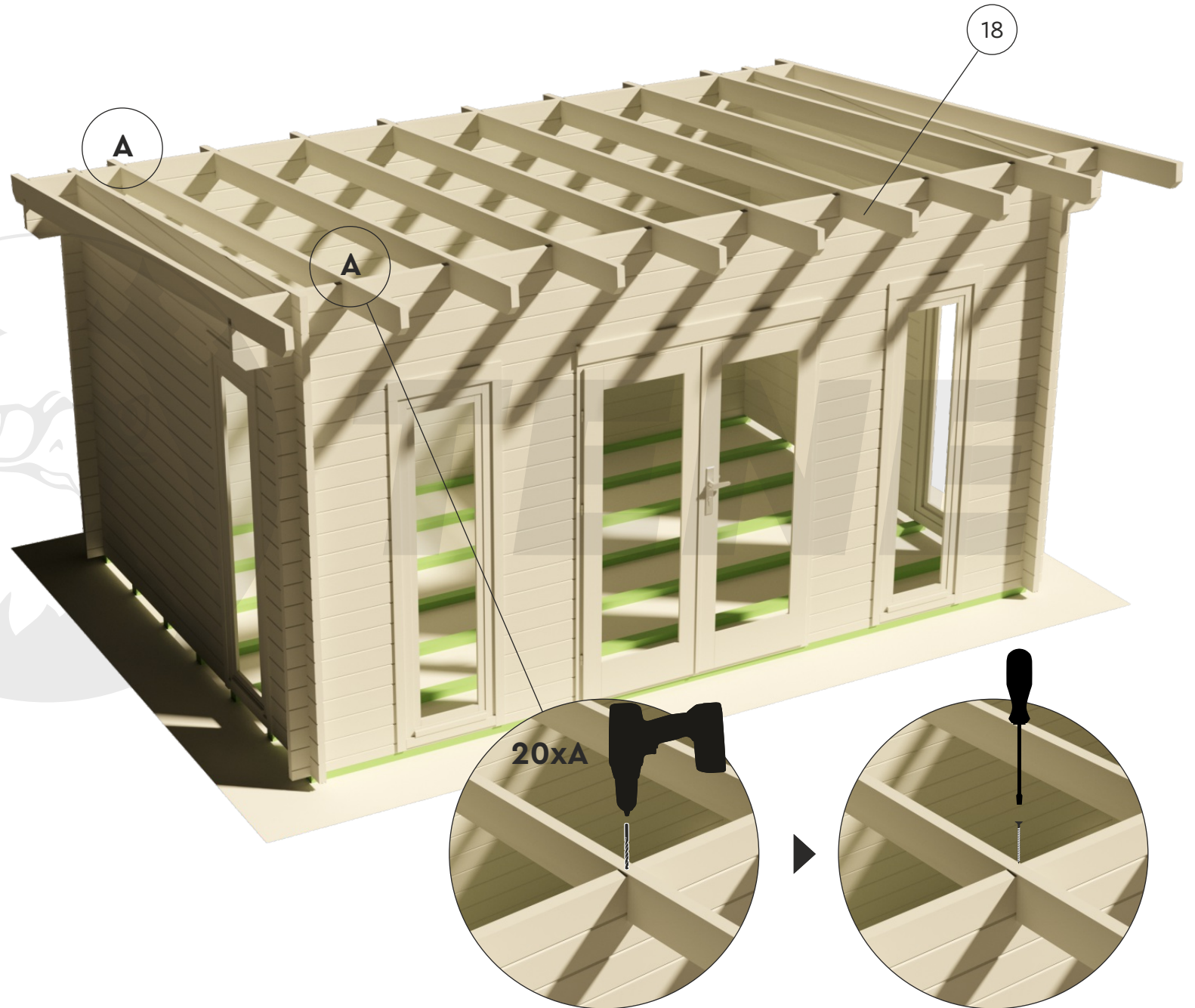

OKLAHOMA 40

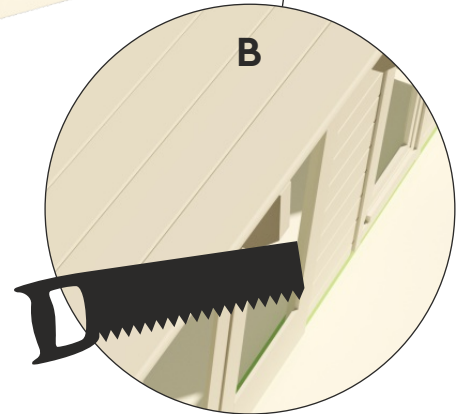
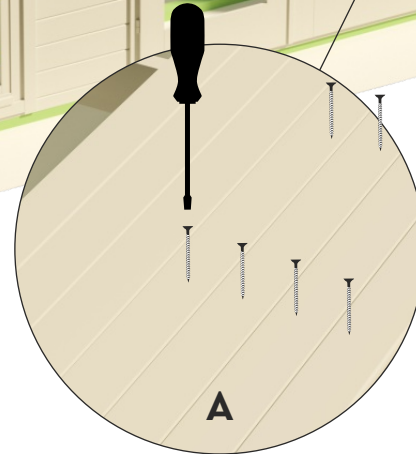
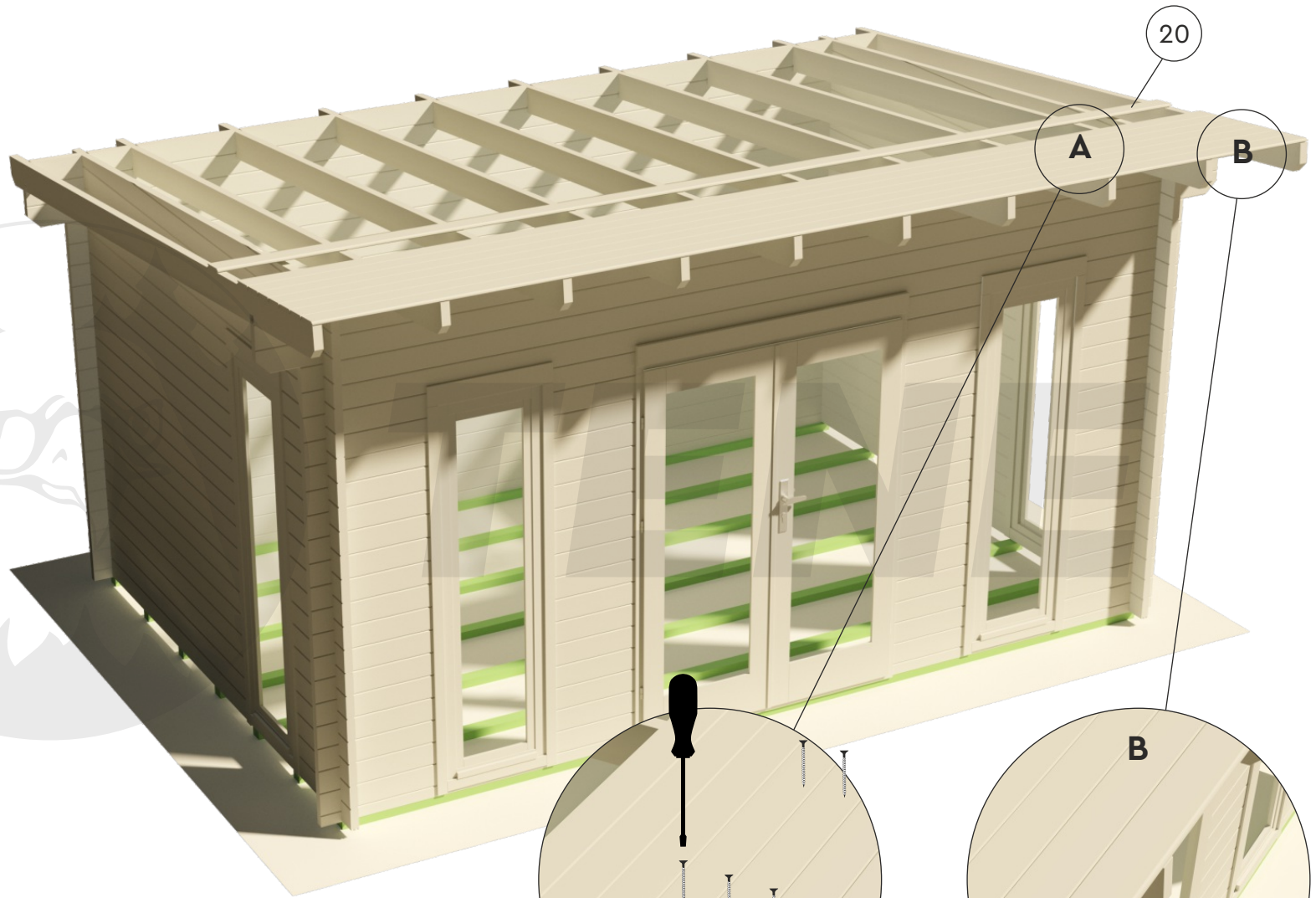

OKLAHOMA 40

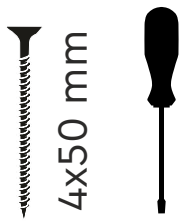
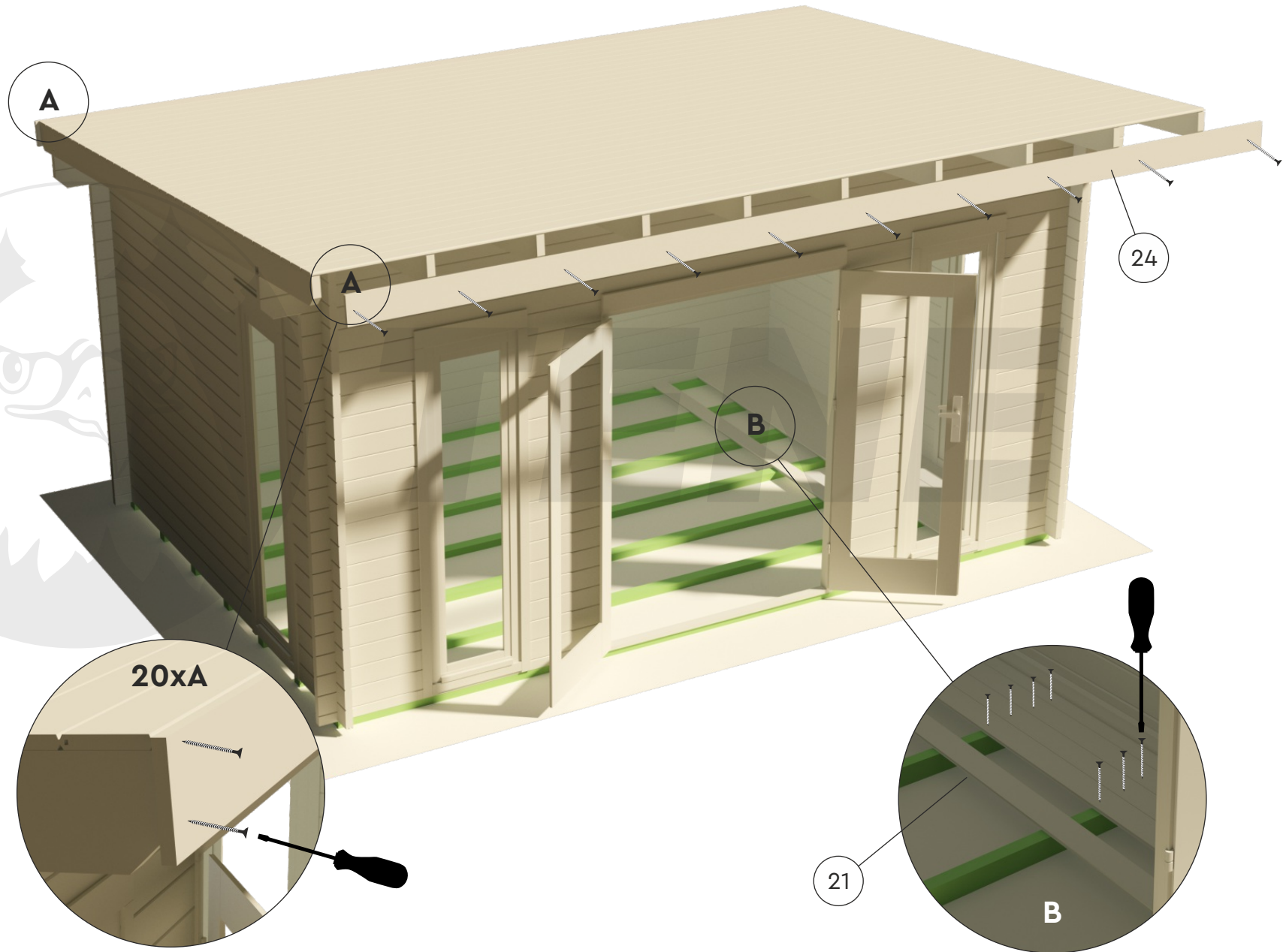

OKLAHOMA 40

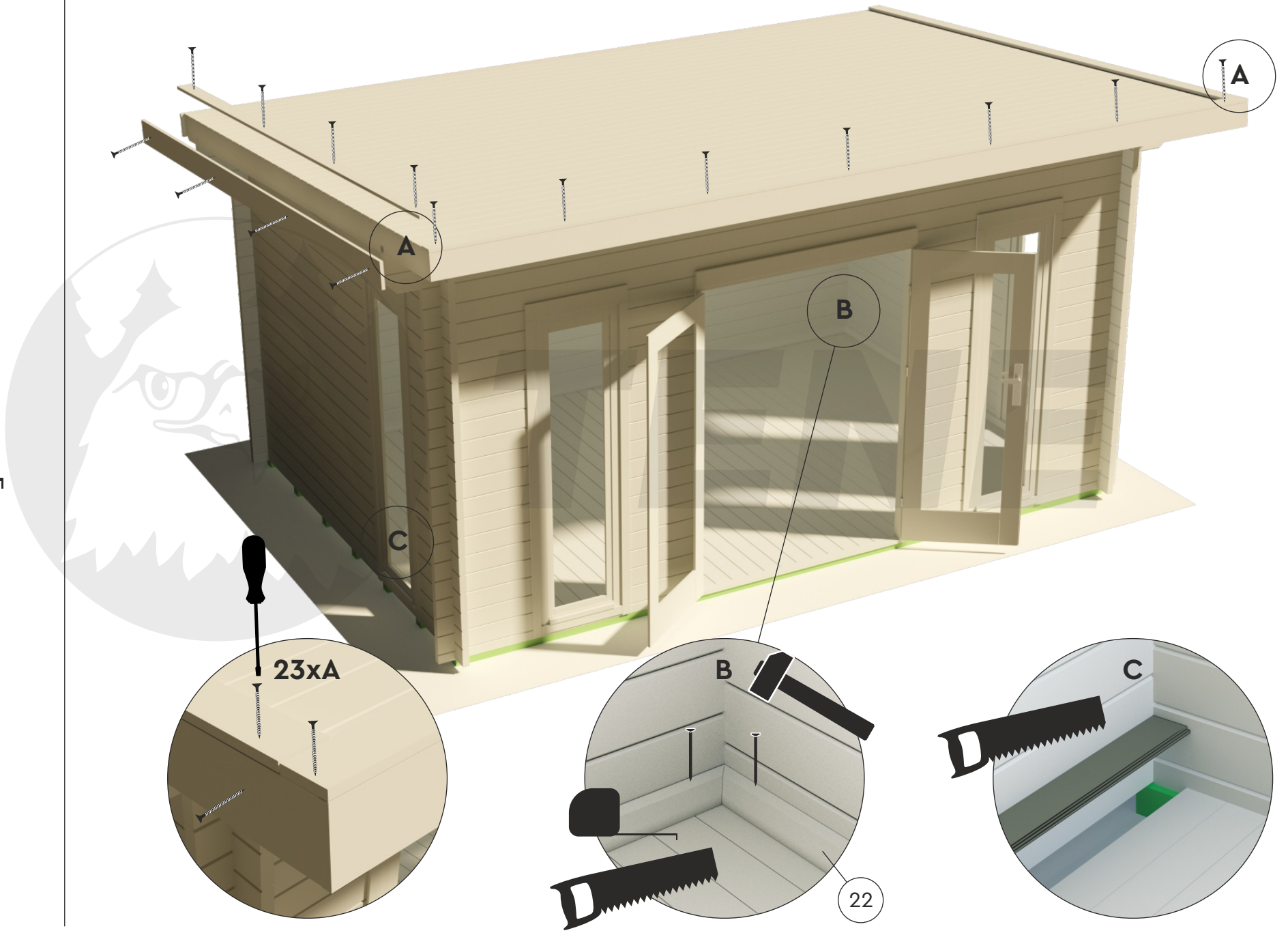
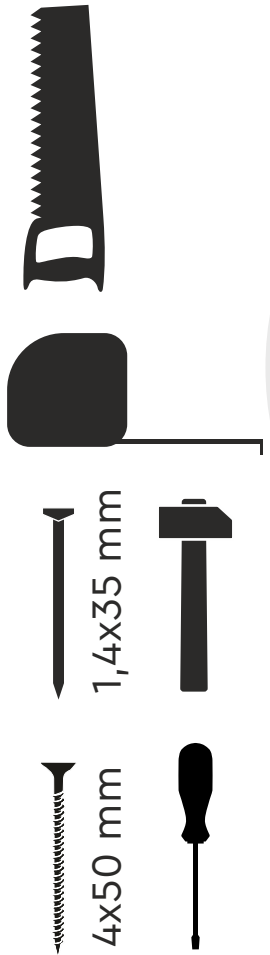

OKLAHOMA 40

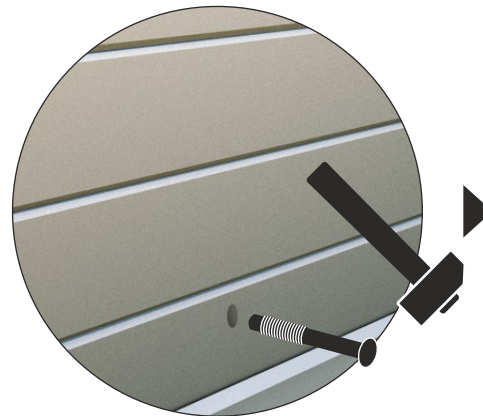
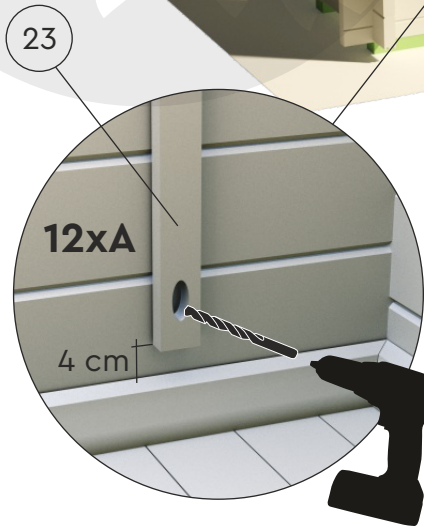
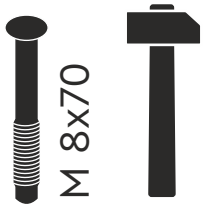
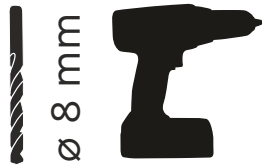
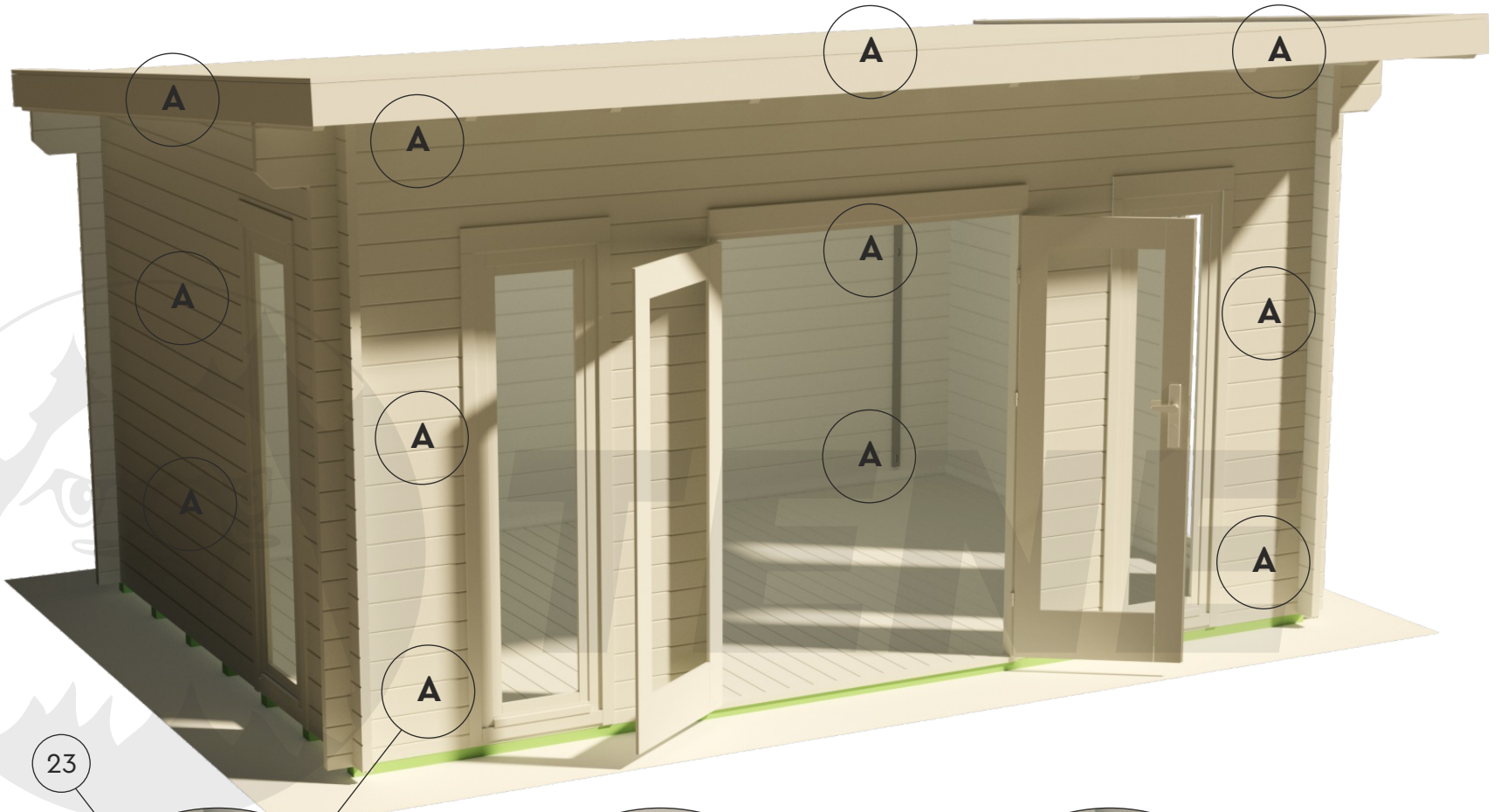

OKLAHOMA 40

